

A

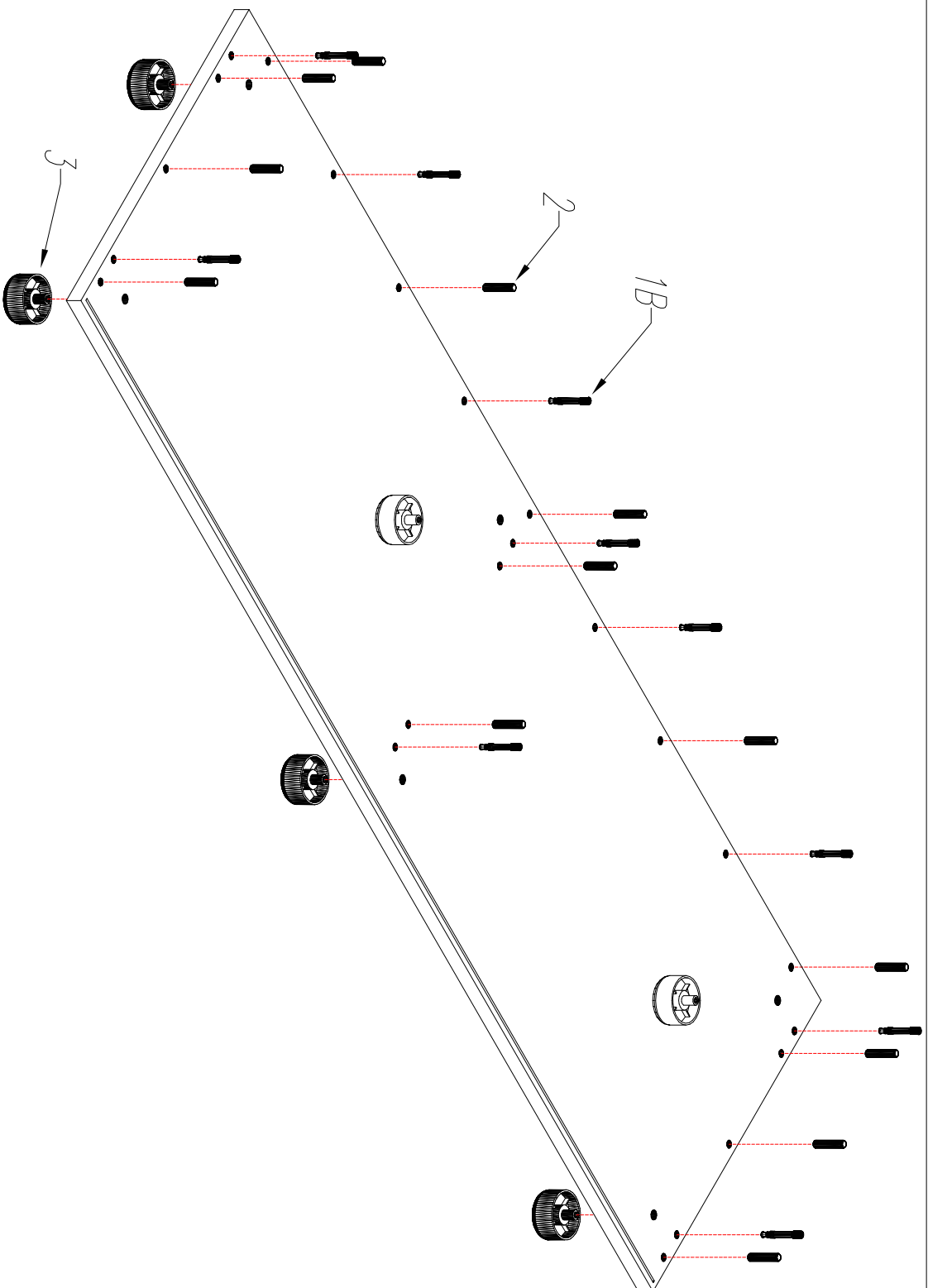

KOLENIŃCZĄ MONTAŻU  
 ИМОСТРОИТЬ I КОЛКОВ.  
 THE FITTINGS SEQUENCE OF THE  
 CAMS AND DOWELS.  
 DIE MONTAGEFOLGE VON  
 EXZENTERN UND DIBBELN.

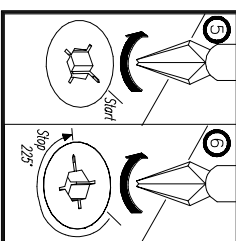

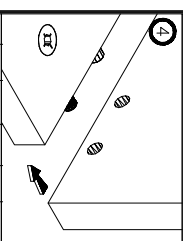
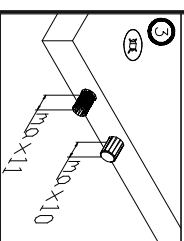
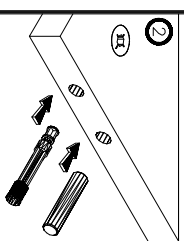
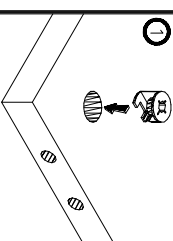
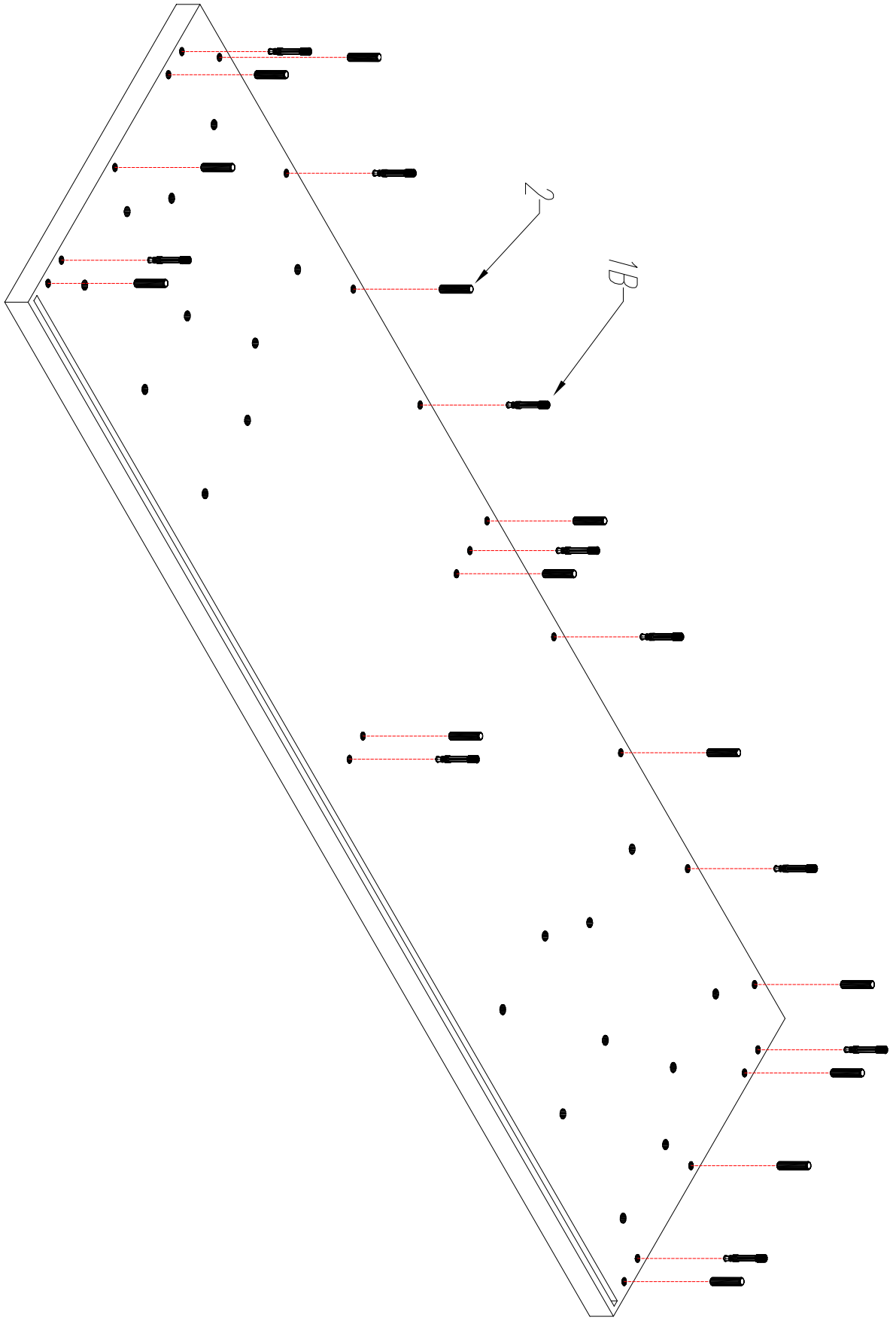

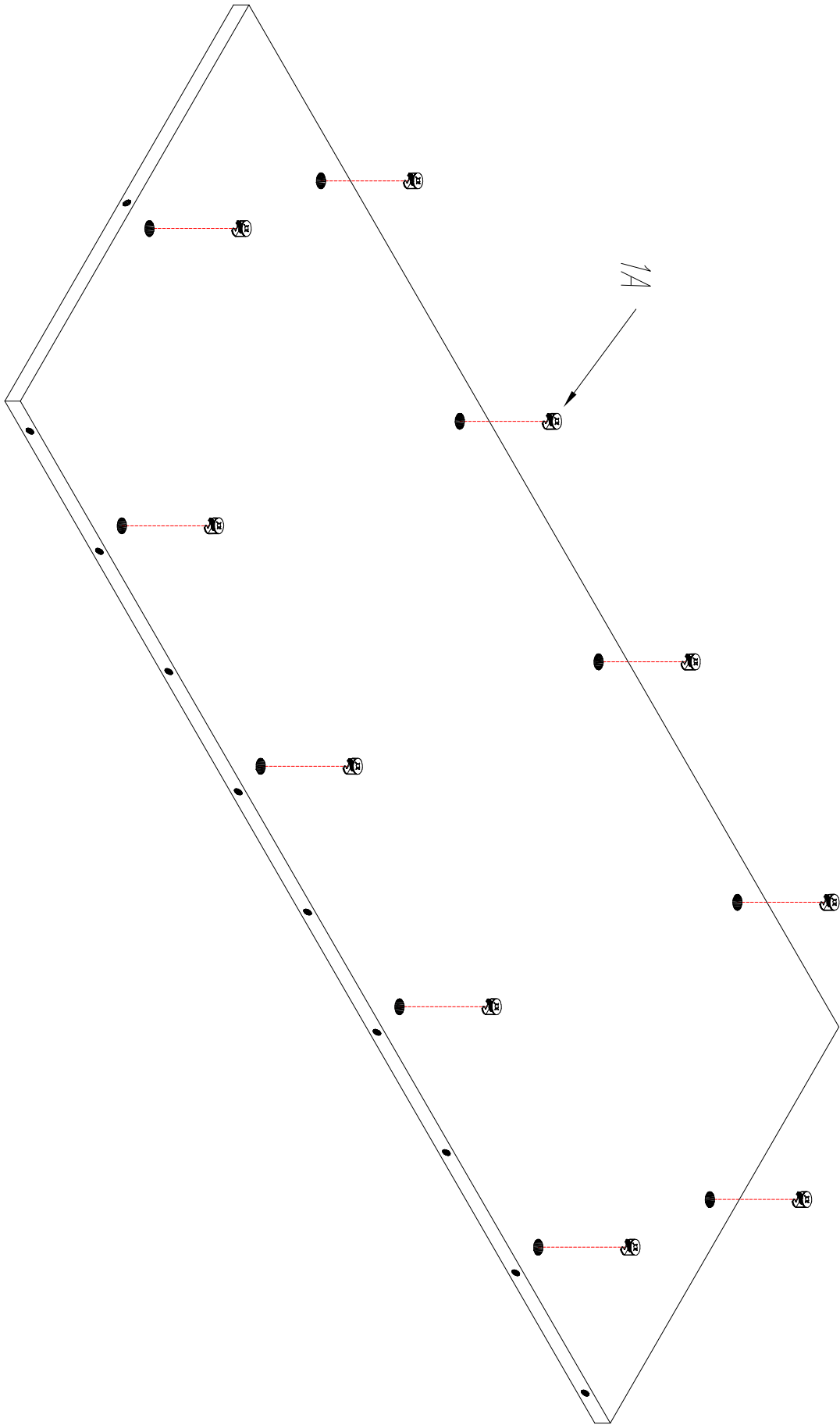

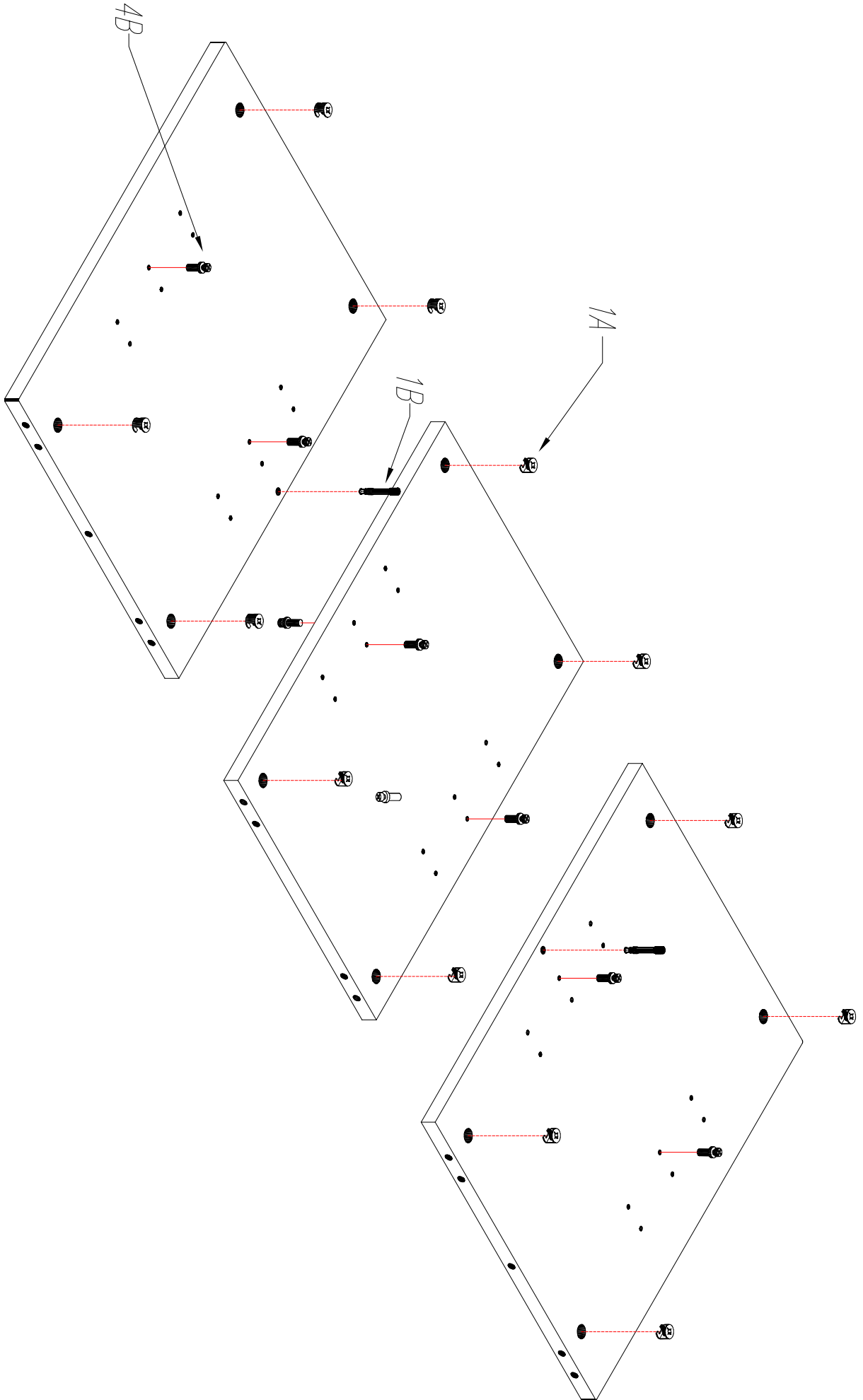

G

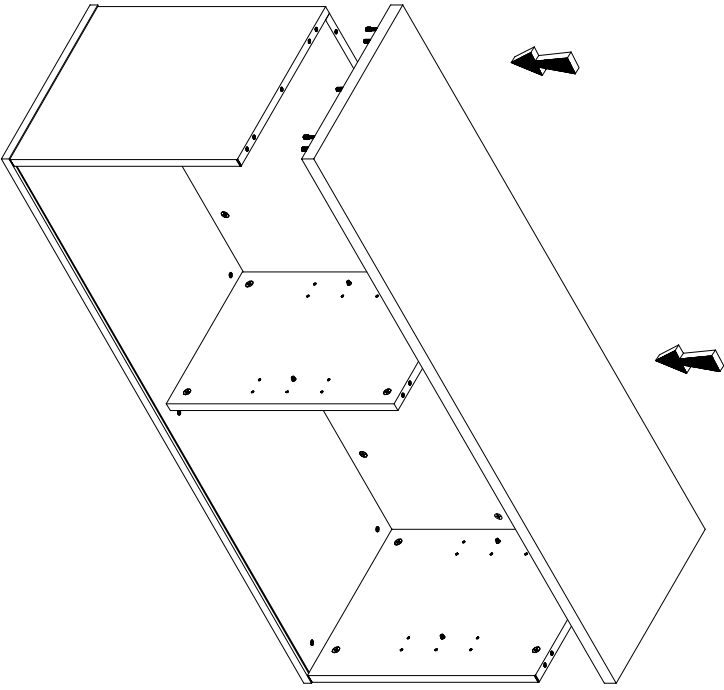

F

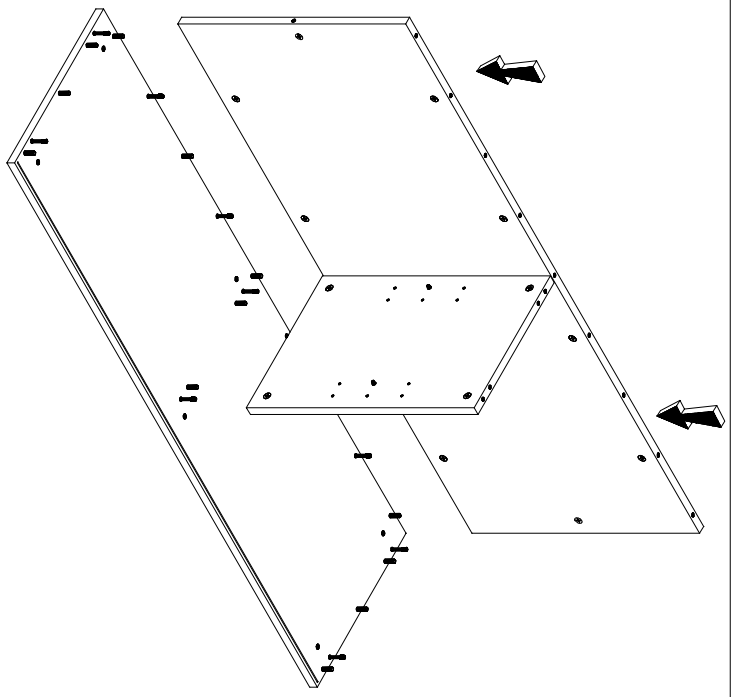

H

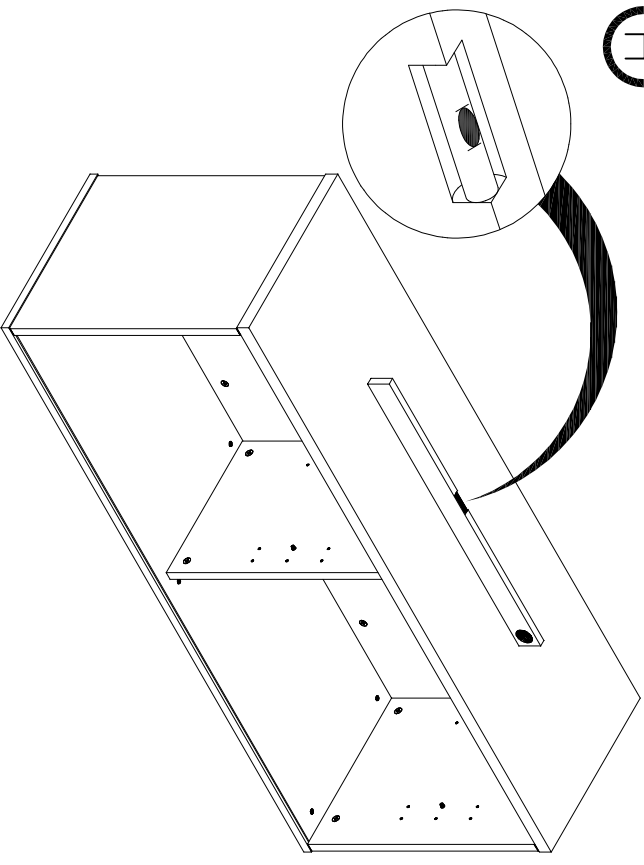

I

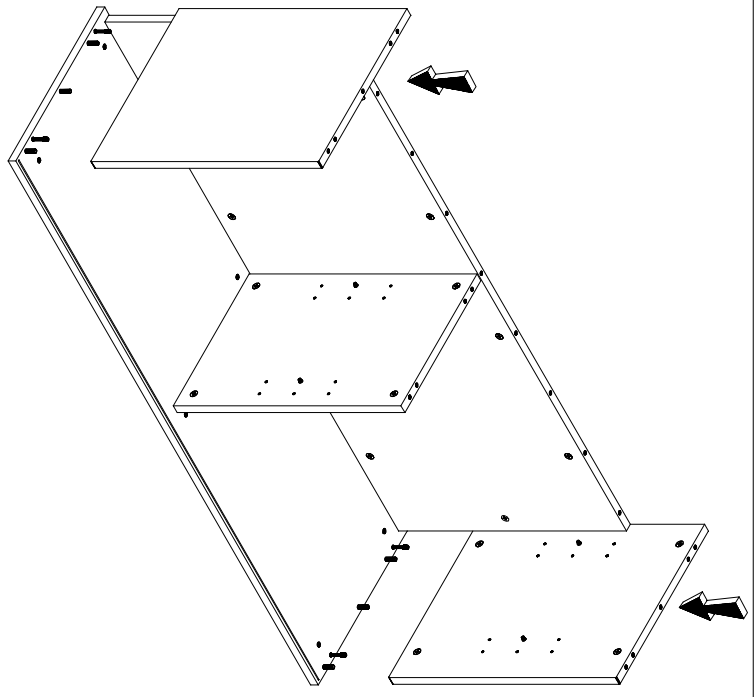

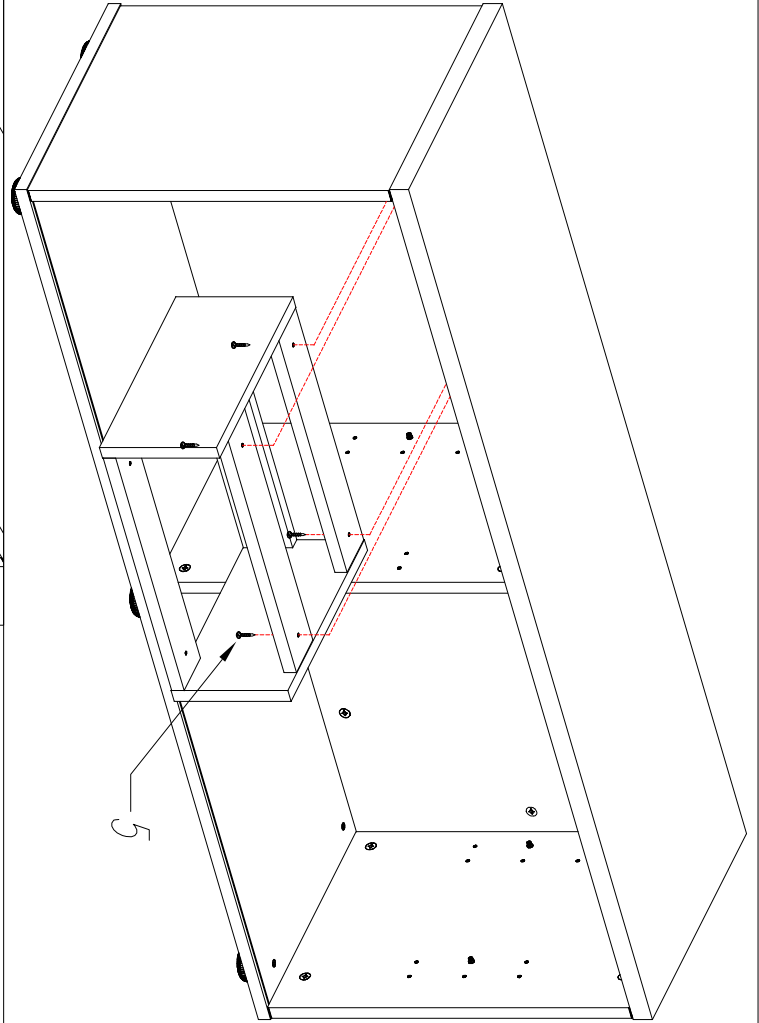
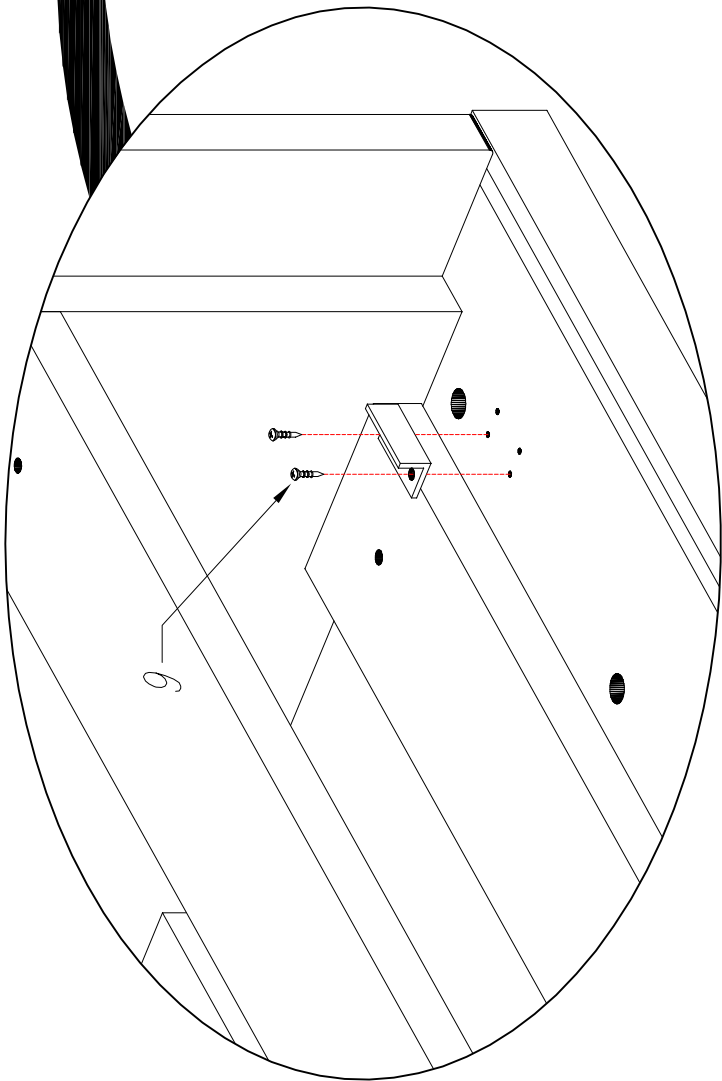
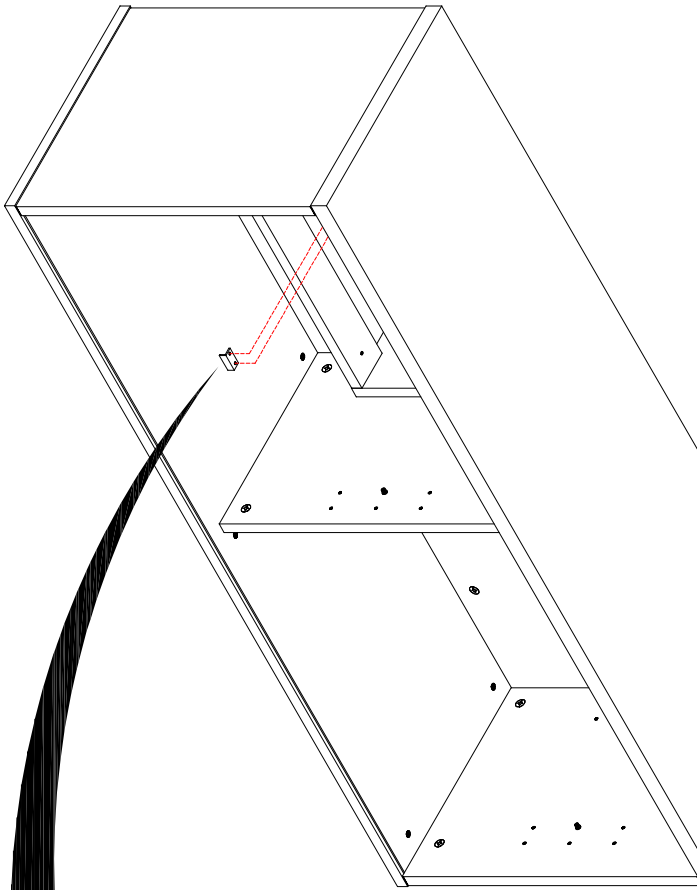

K

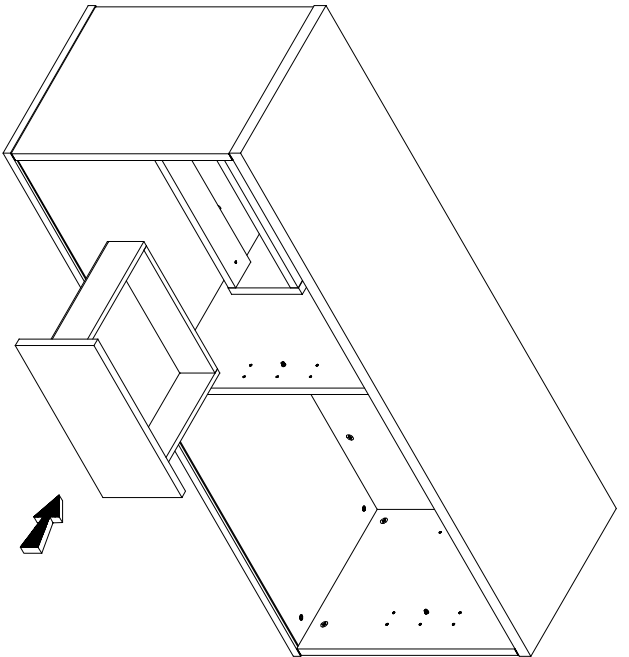

L

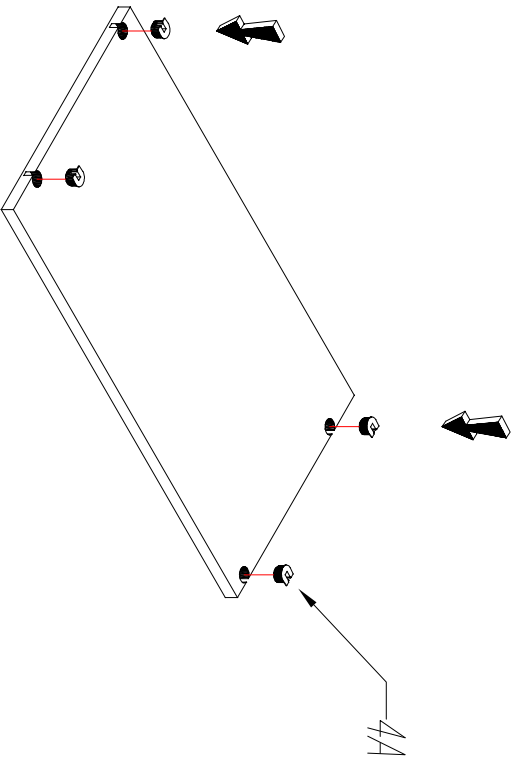

-Przykręcić śruby z  
małą siłą.  
-Put the screws gently.  
-Anschrauben die  
Schrauben zierlich.

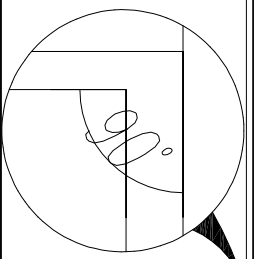
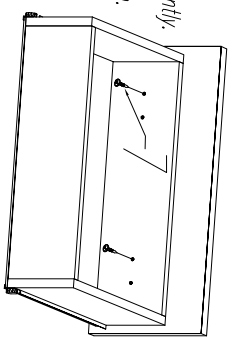

-Przykręcić śruby z  
dużą siłą.  
-Put the screws strongly.  
-Anschrauben die  
Schrauben staerlich.

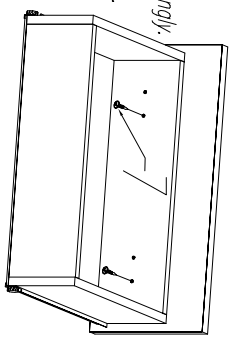

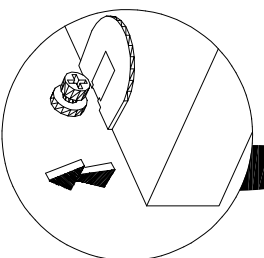
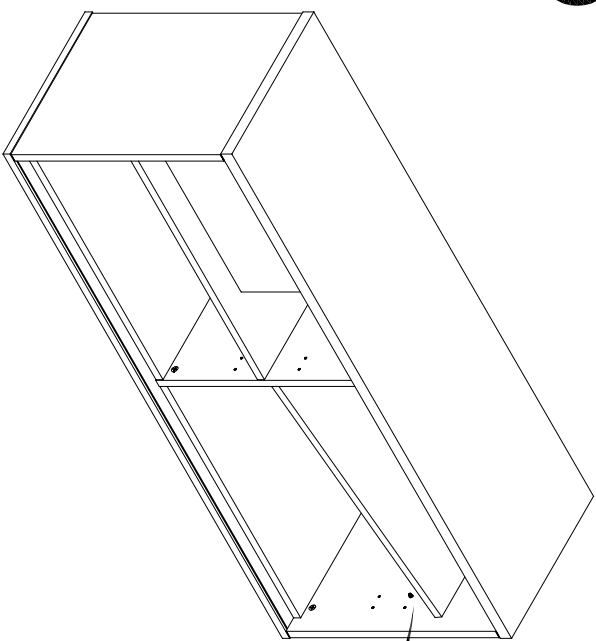

M

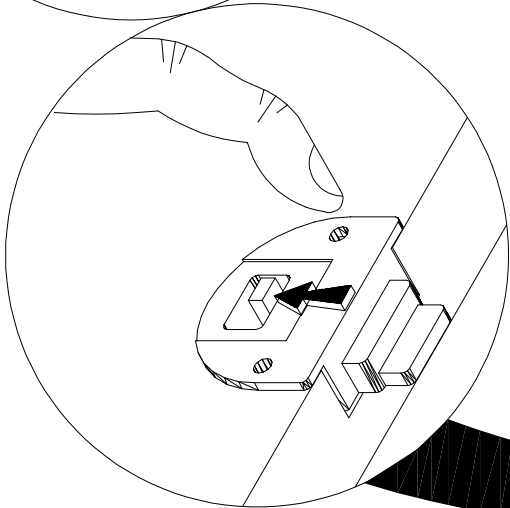
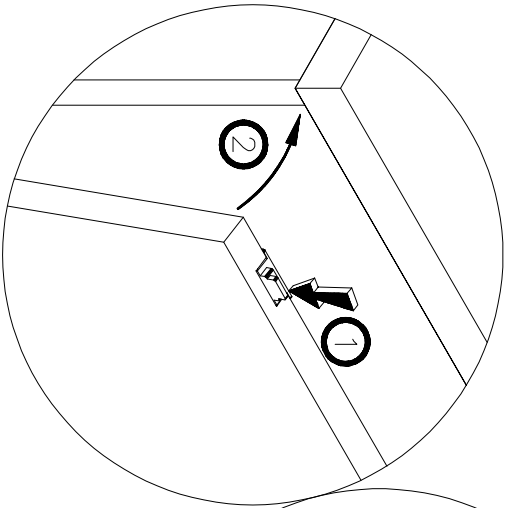
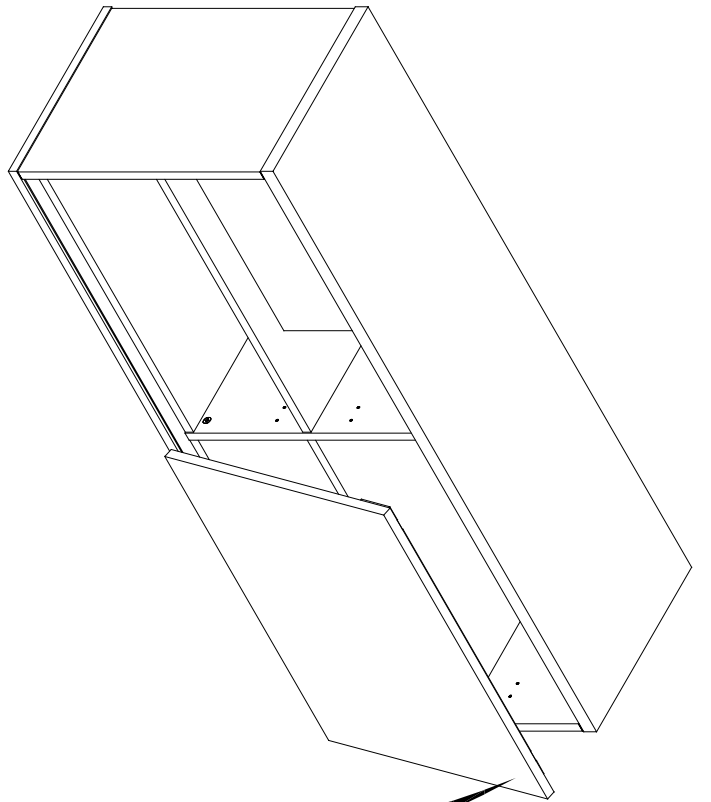
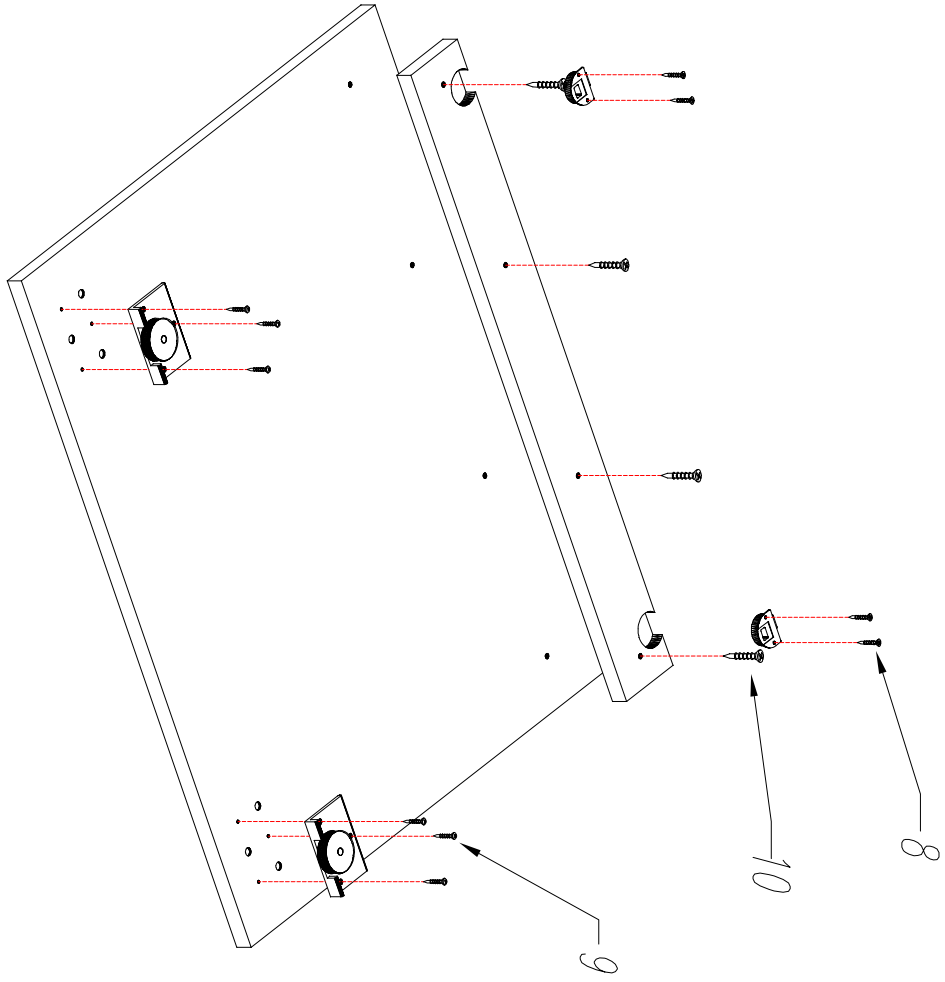



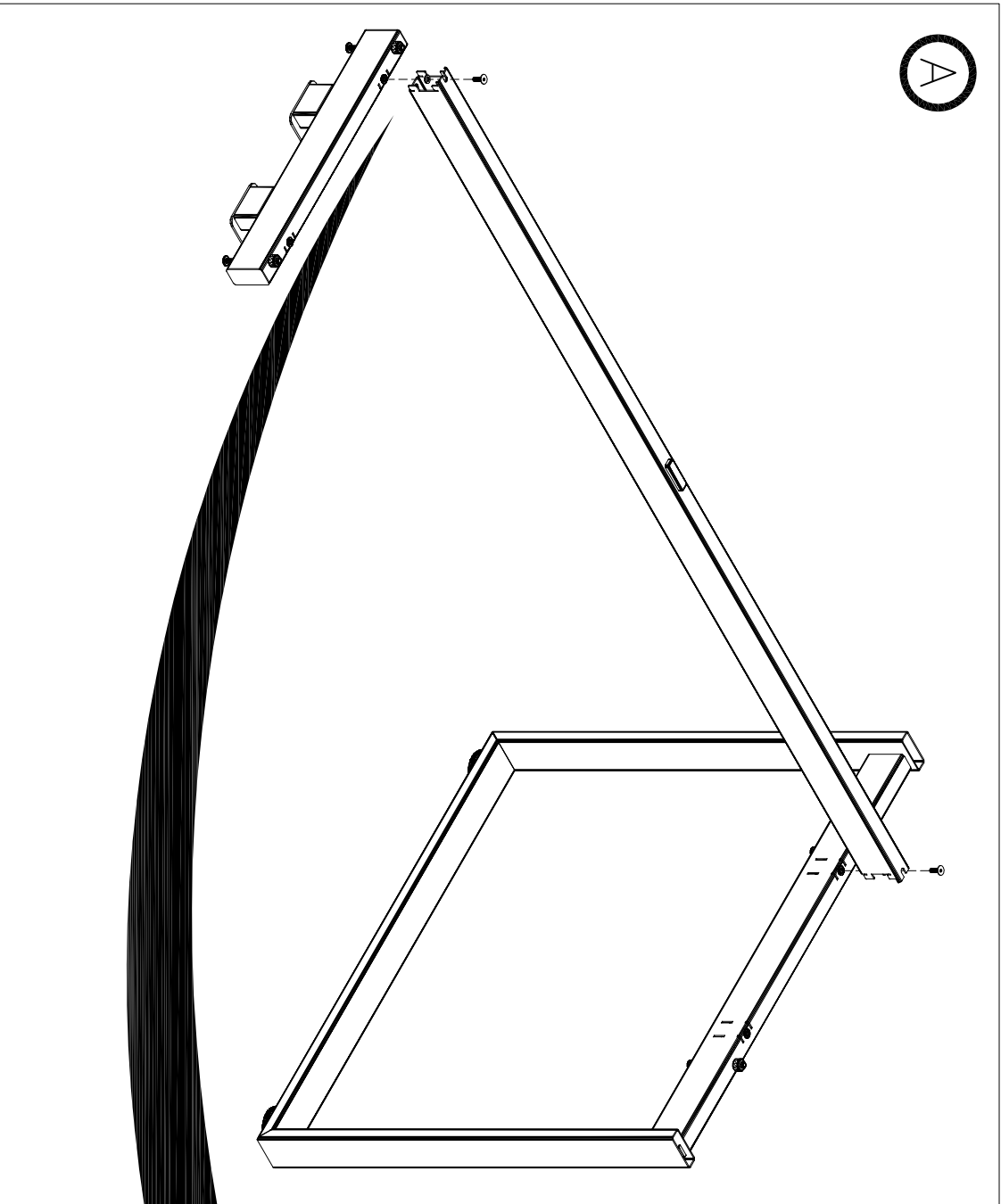

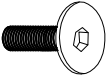

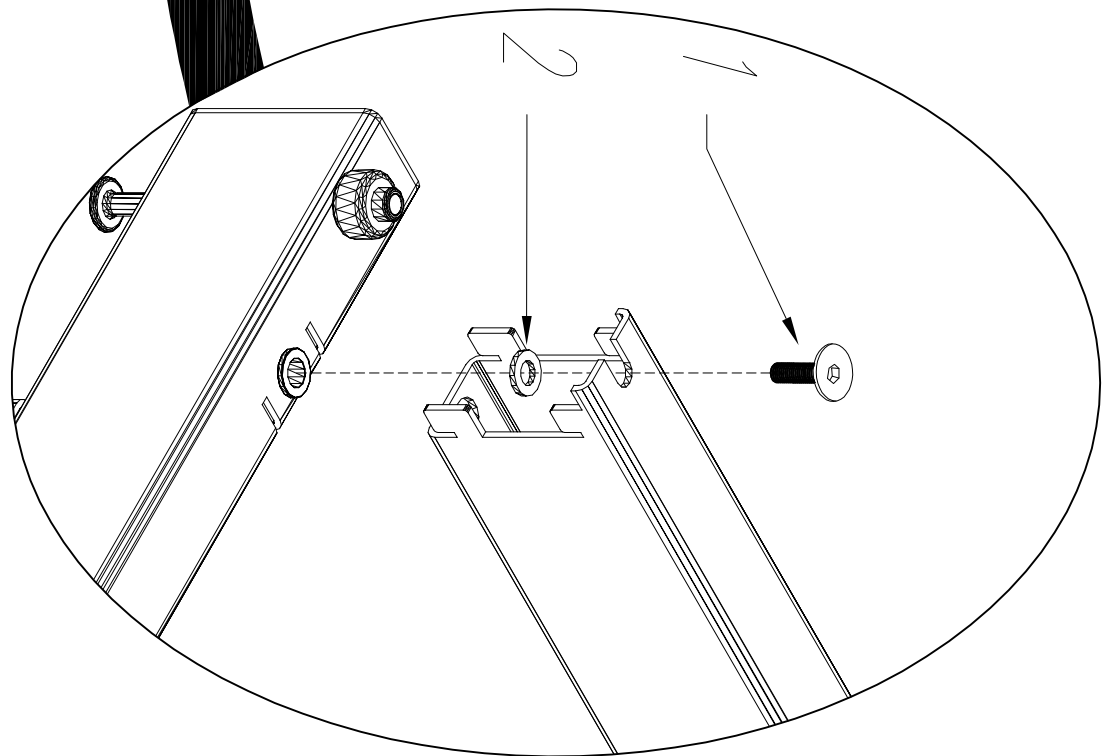

1		M6x20B
2		M6
3		M6



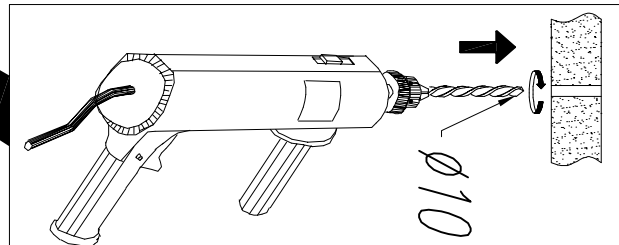
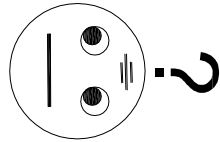
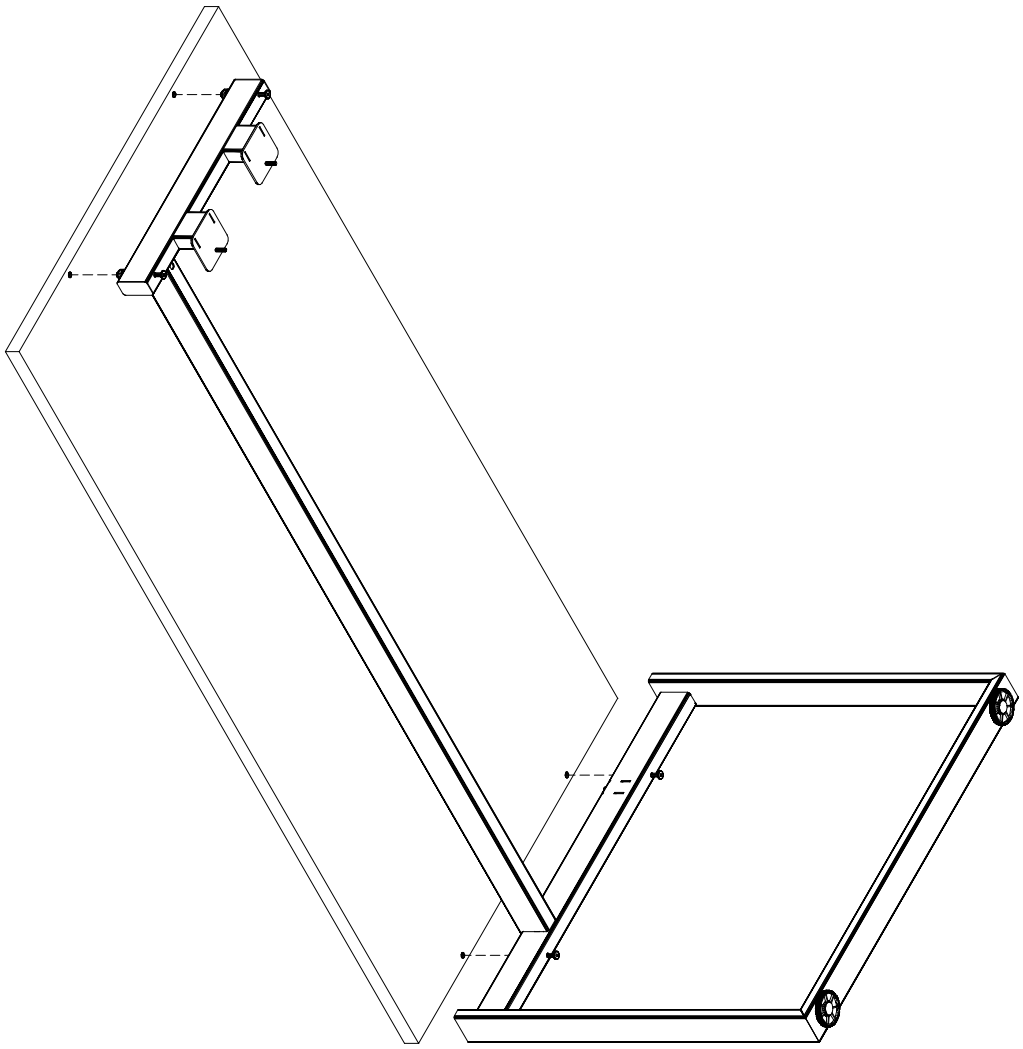

**OGI**

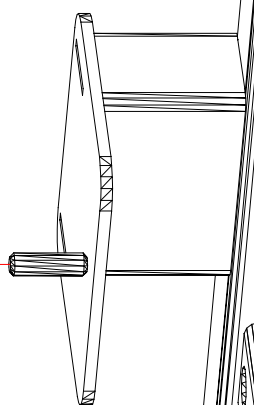
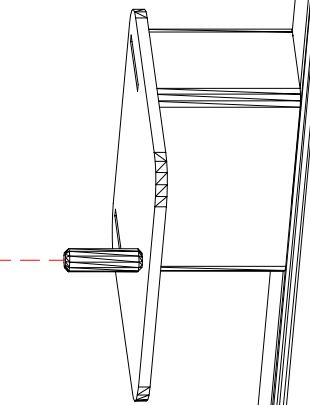
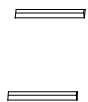

D



3

