

A

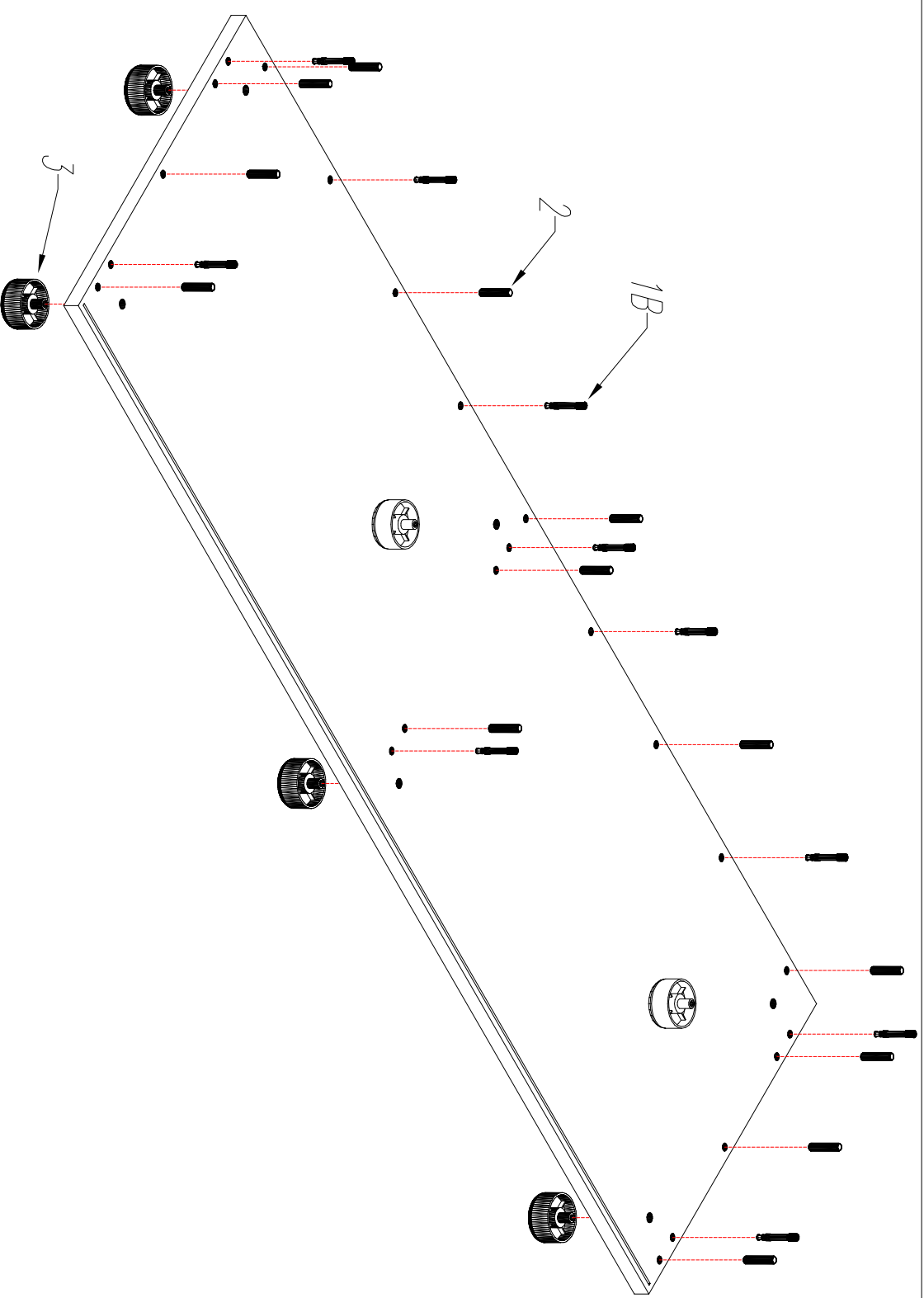

KOLEJNOŚĆ MONTAŻU
 ИМХОСРОДОНІ І КОРКОН.
 THE FITTING SEQUENCE OF THE
 CAMS AND DOWELS.
 DIE MONTAGEFOLGE VON
 EXZENTERN UND DIBBELN.

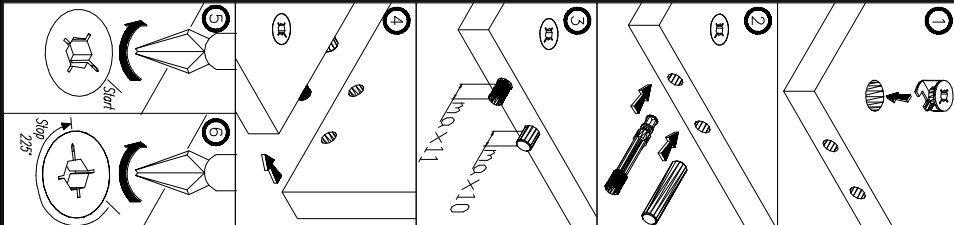

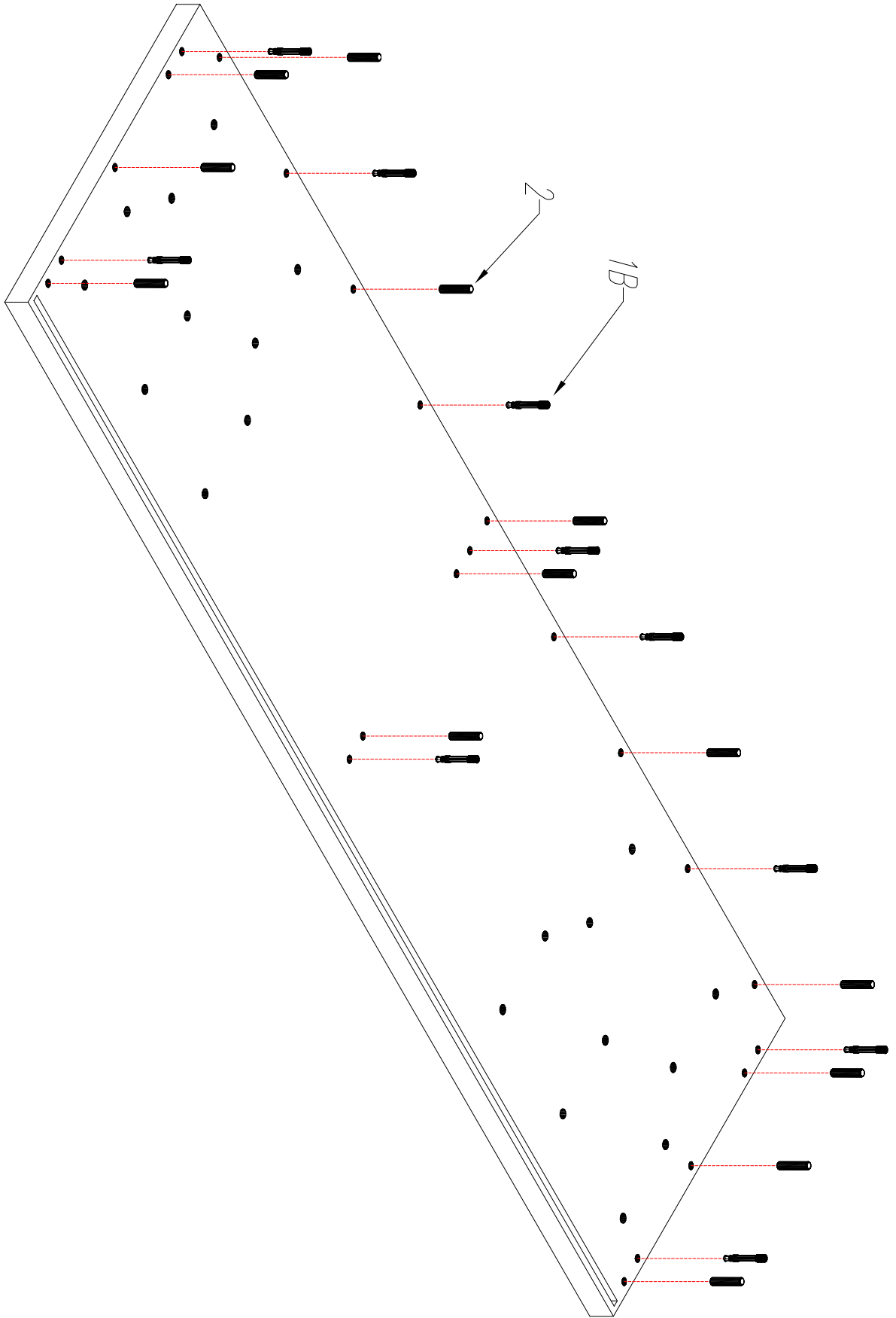

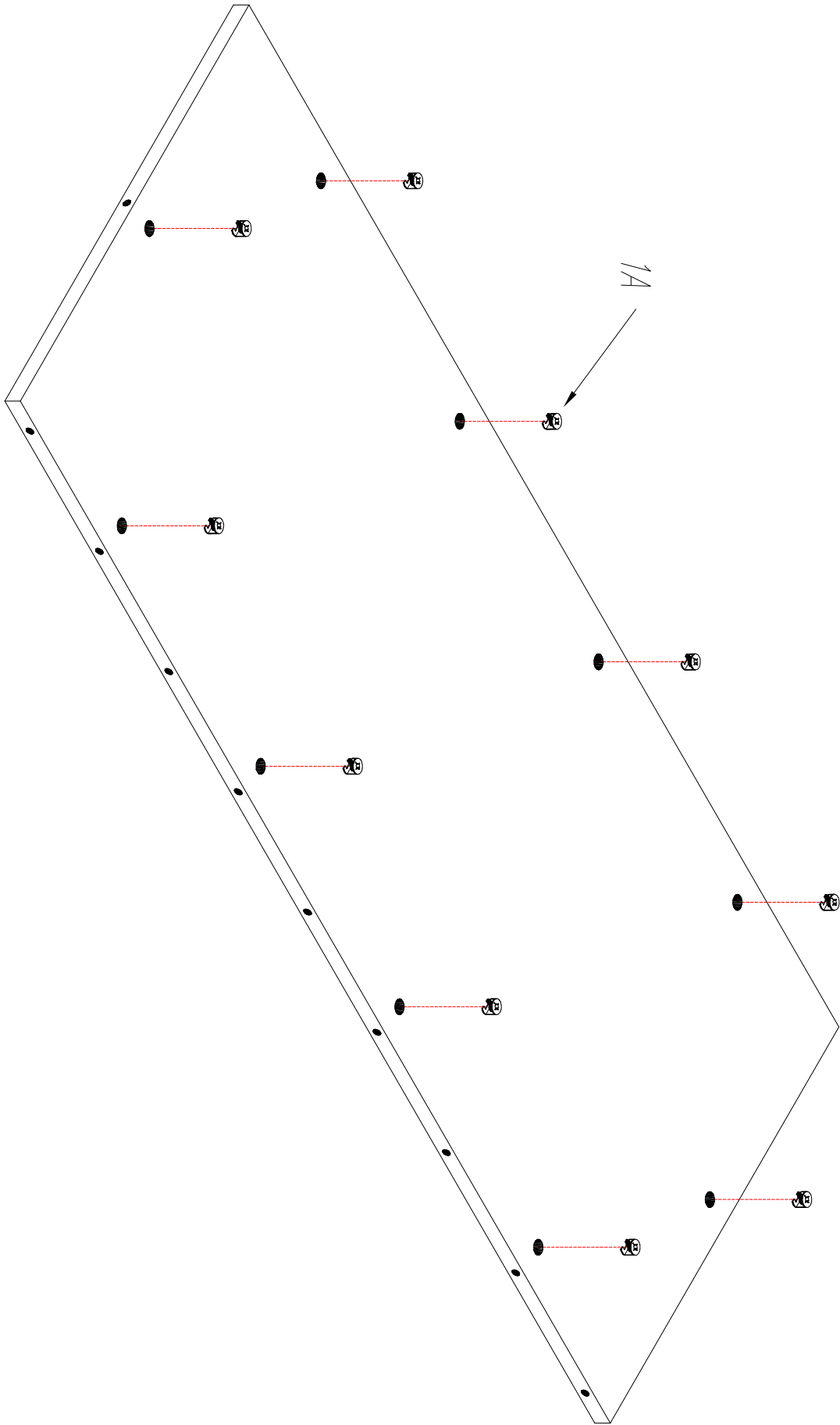

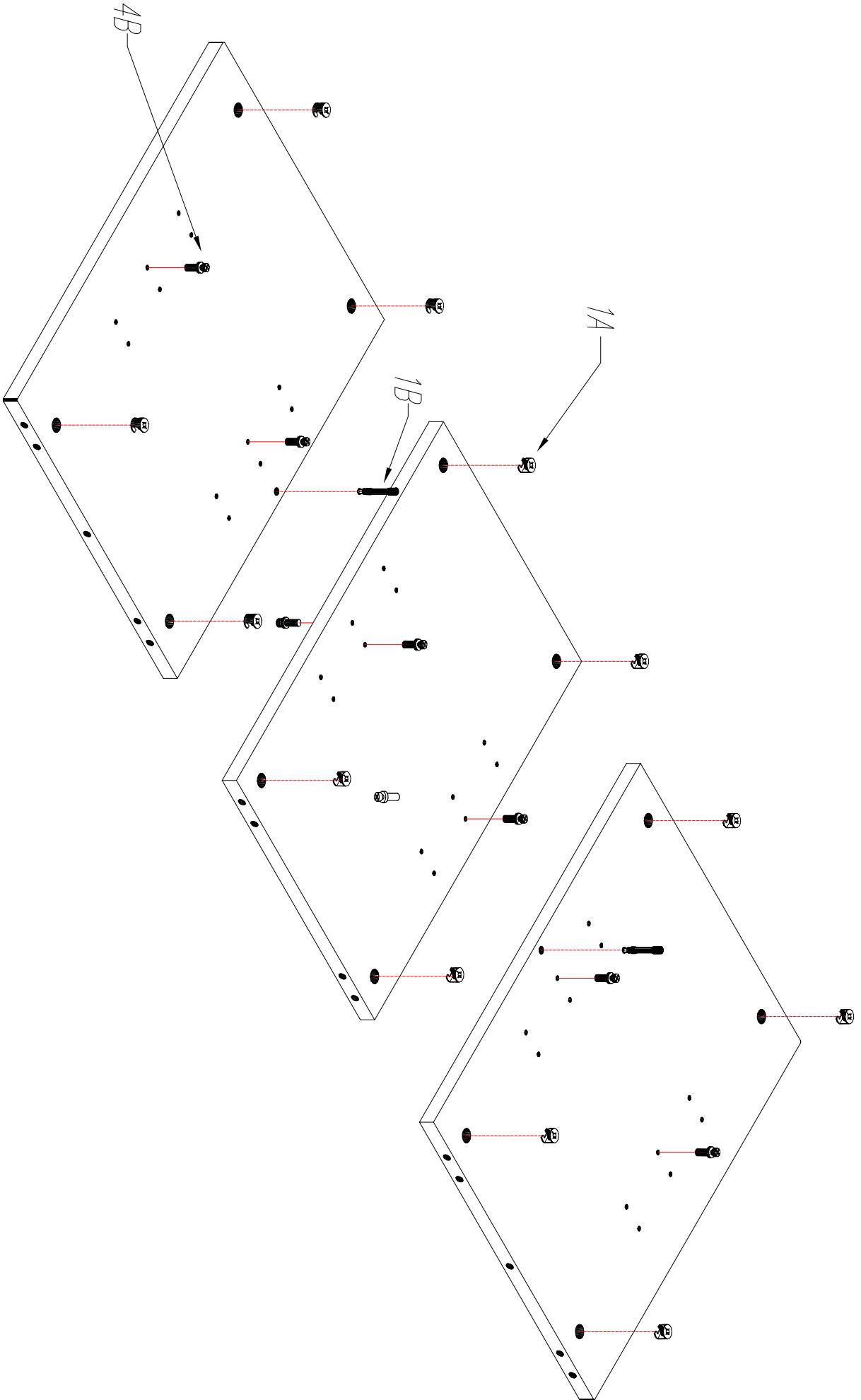

G

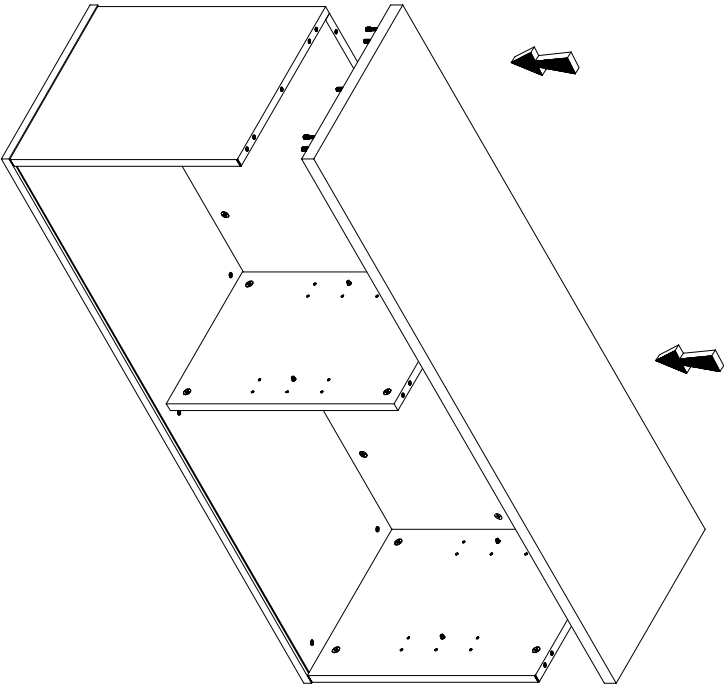

F

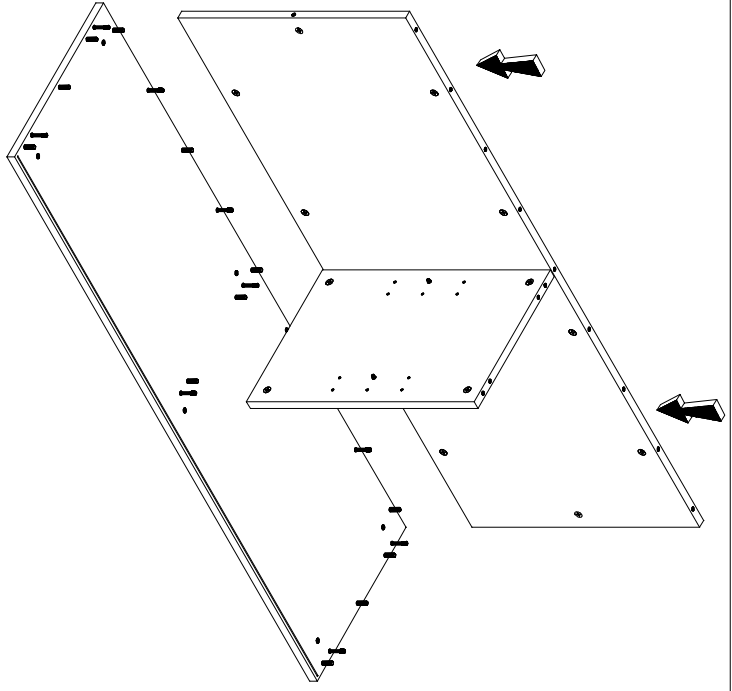

H

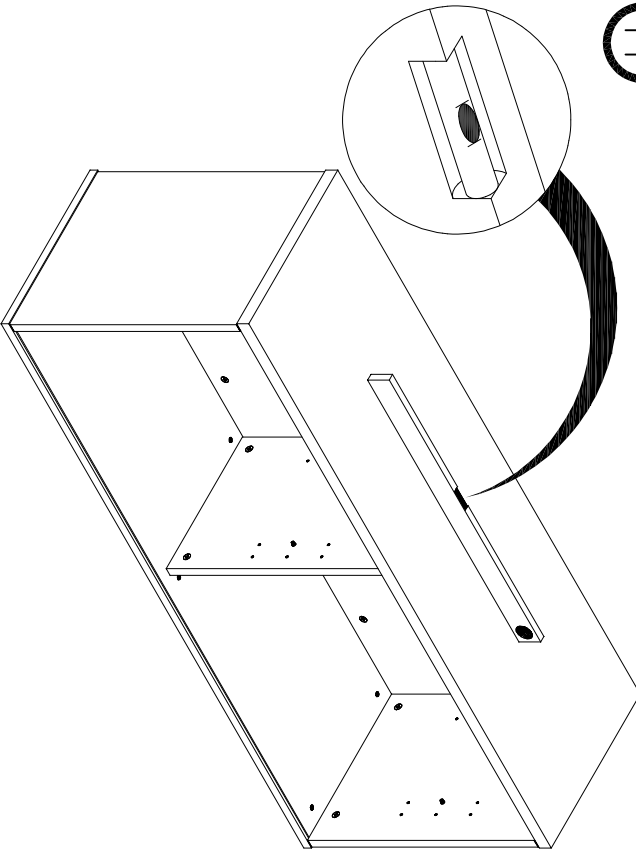

I

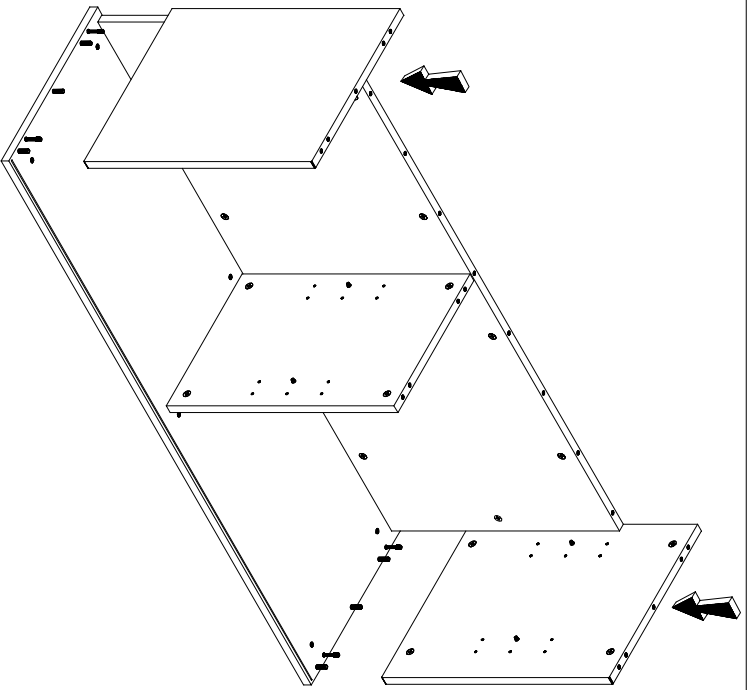

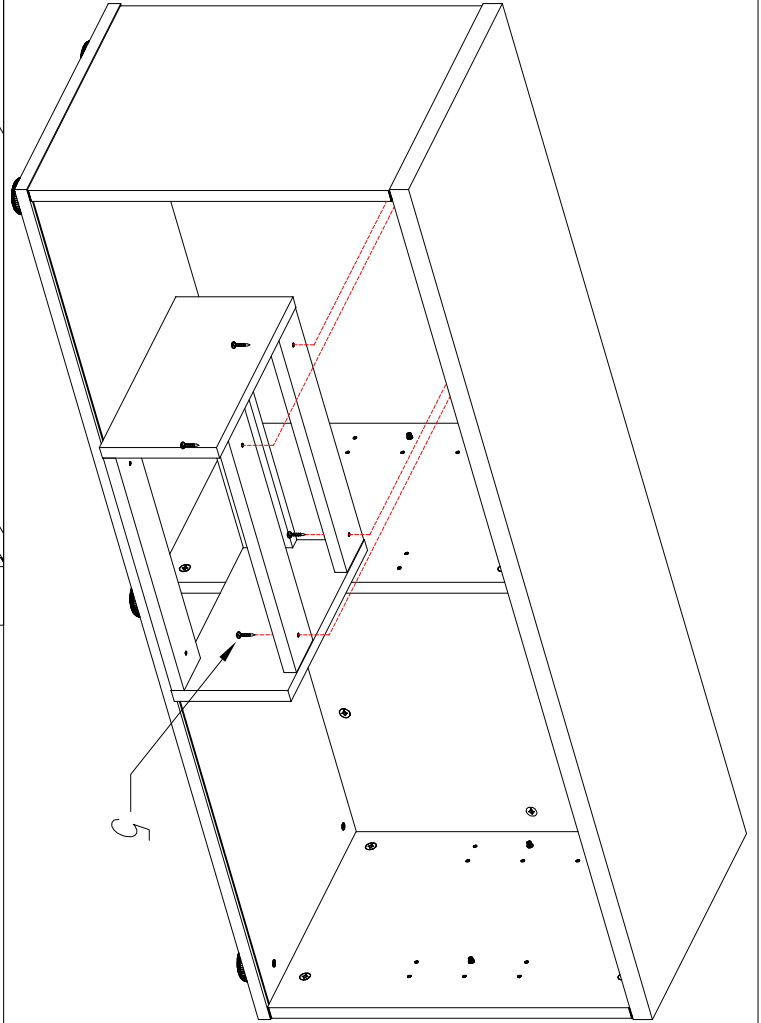
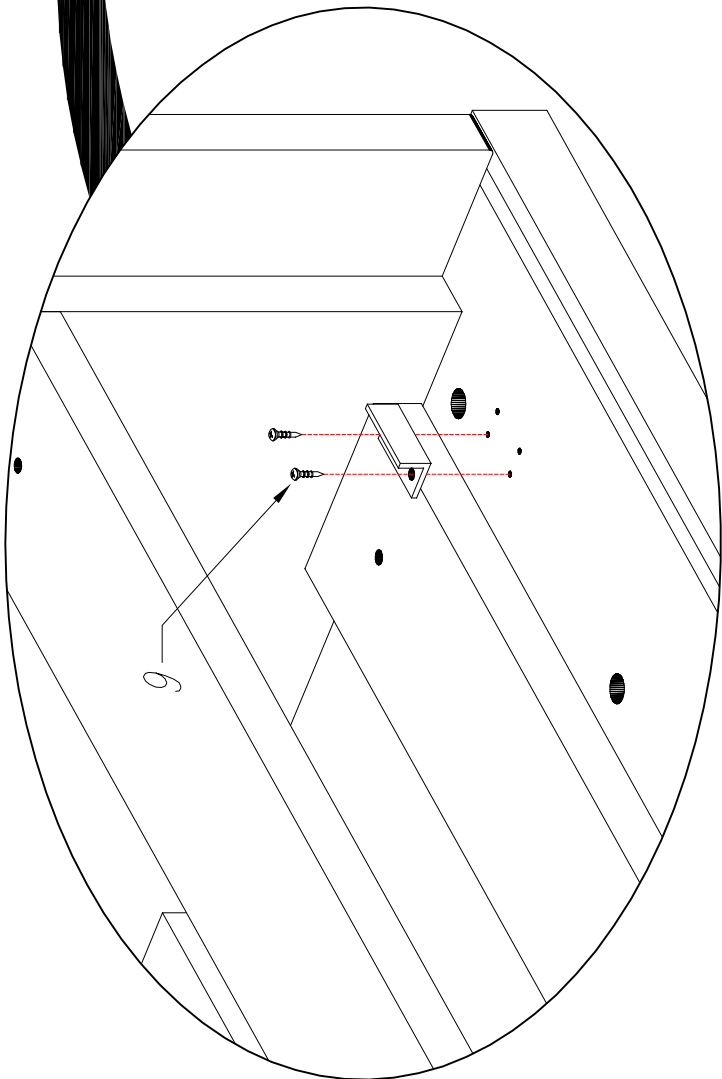
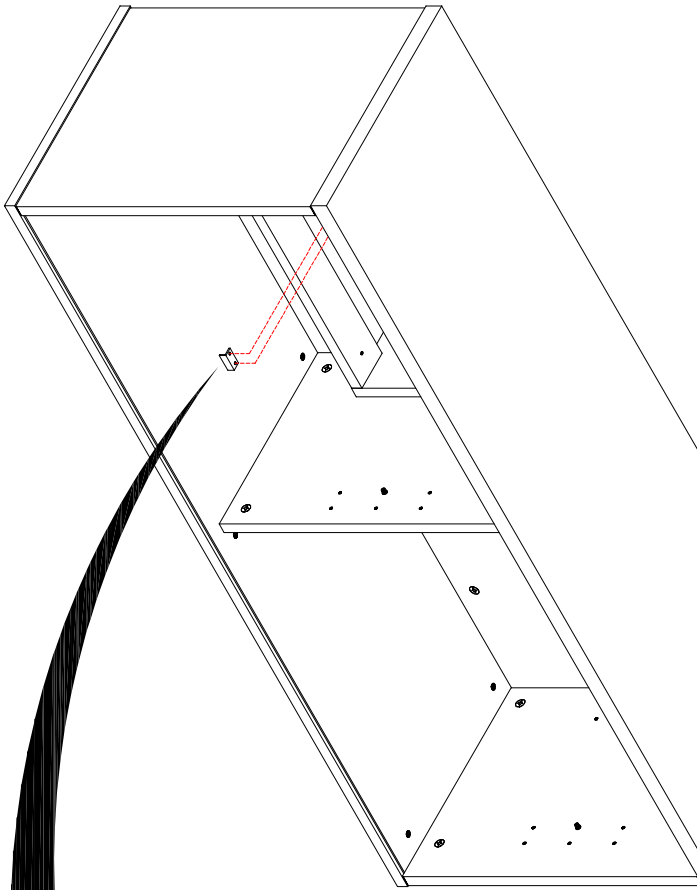

K

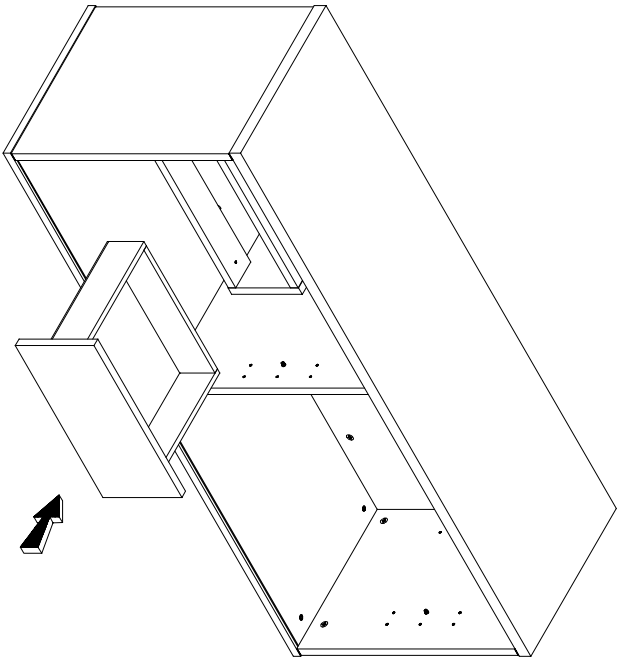

L

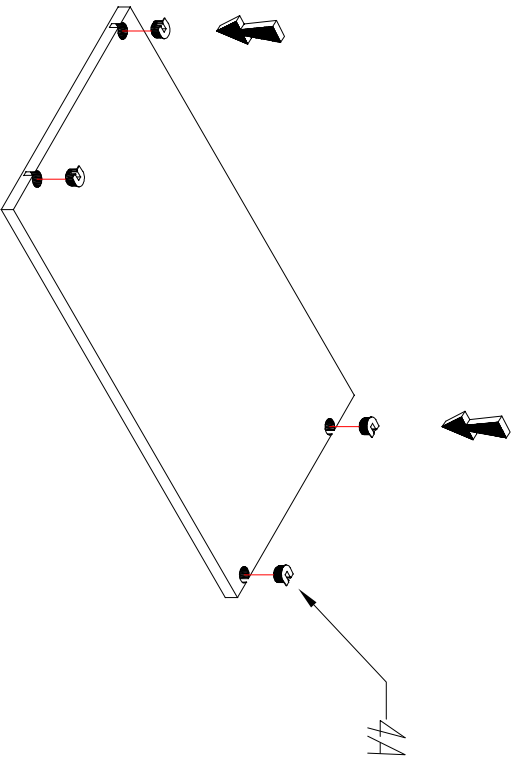

-Przykręcić śruby z
małą siłą.
-Put the screws gently.
-Anschrauben die
Schrauben zierlich.

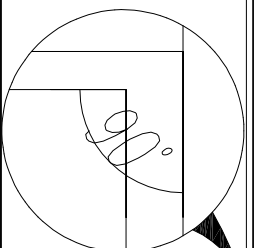
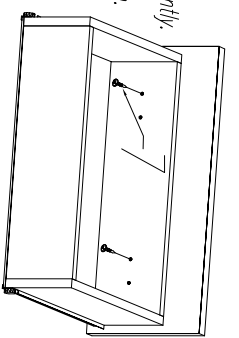

-Przykręcić śruby z
dużą siłą.
-Put the screws strongly.
-Anschrauben die
Schrauben staerlich.

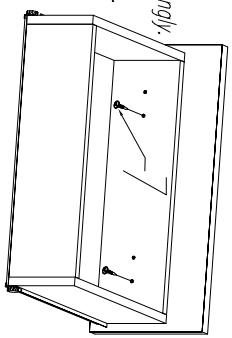

M

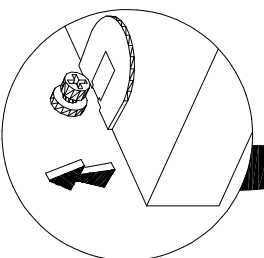
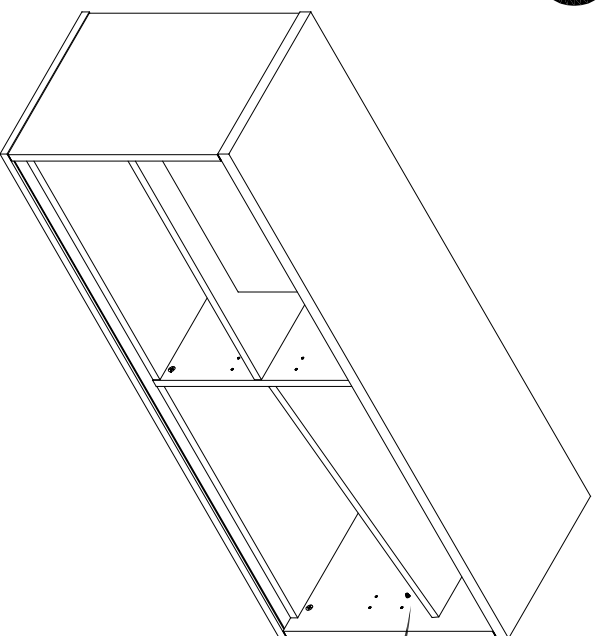

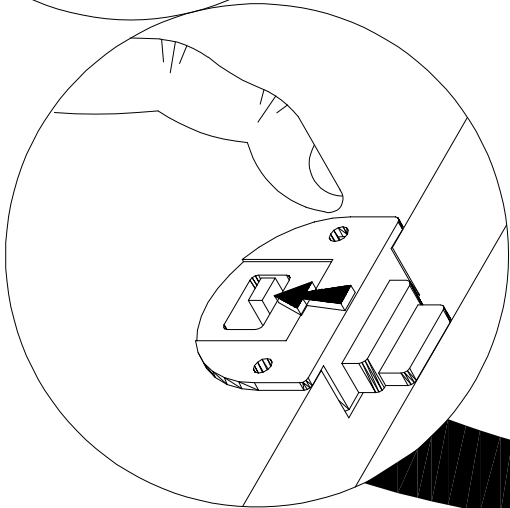
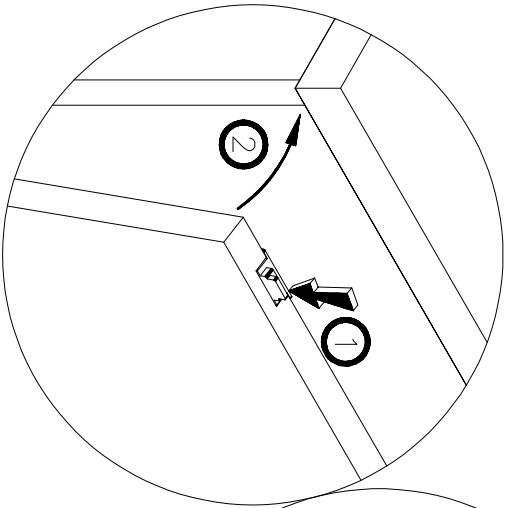
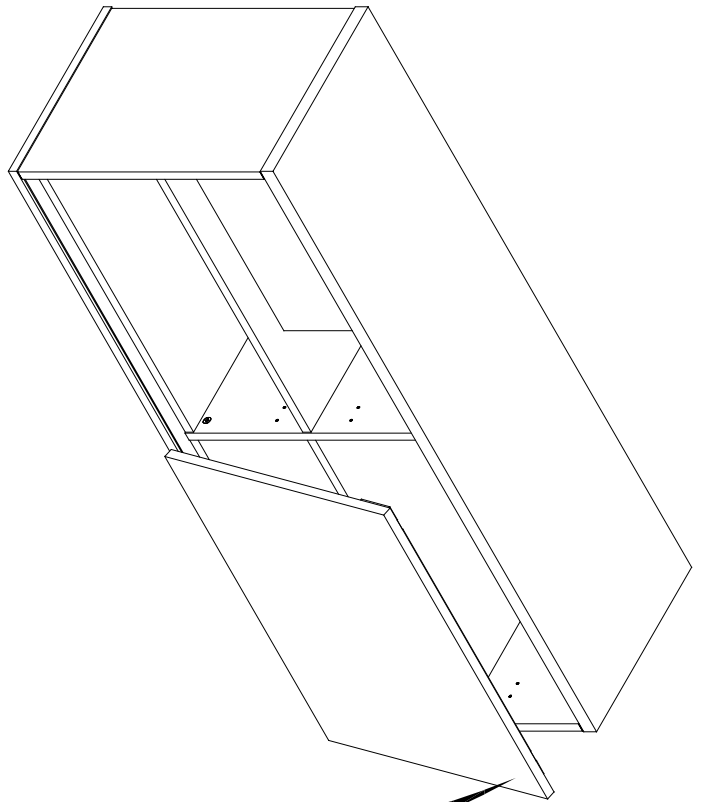
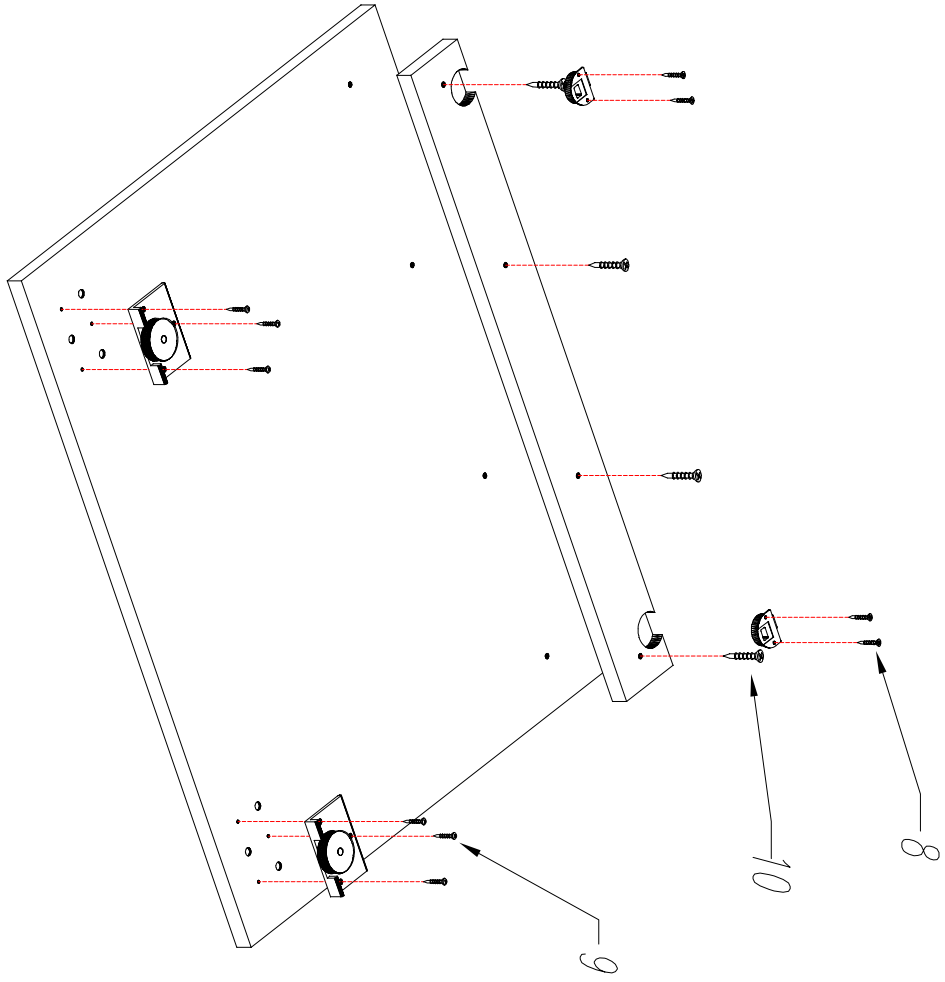

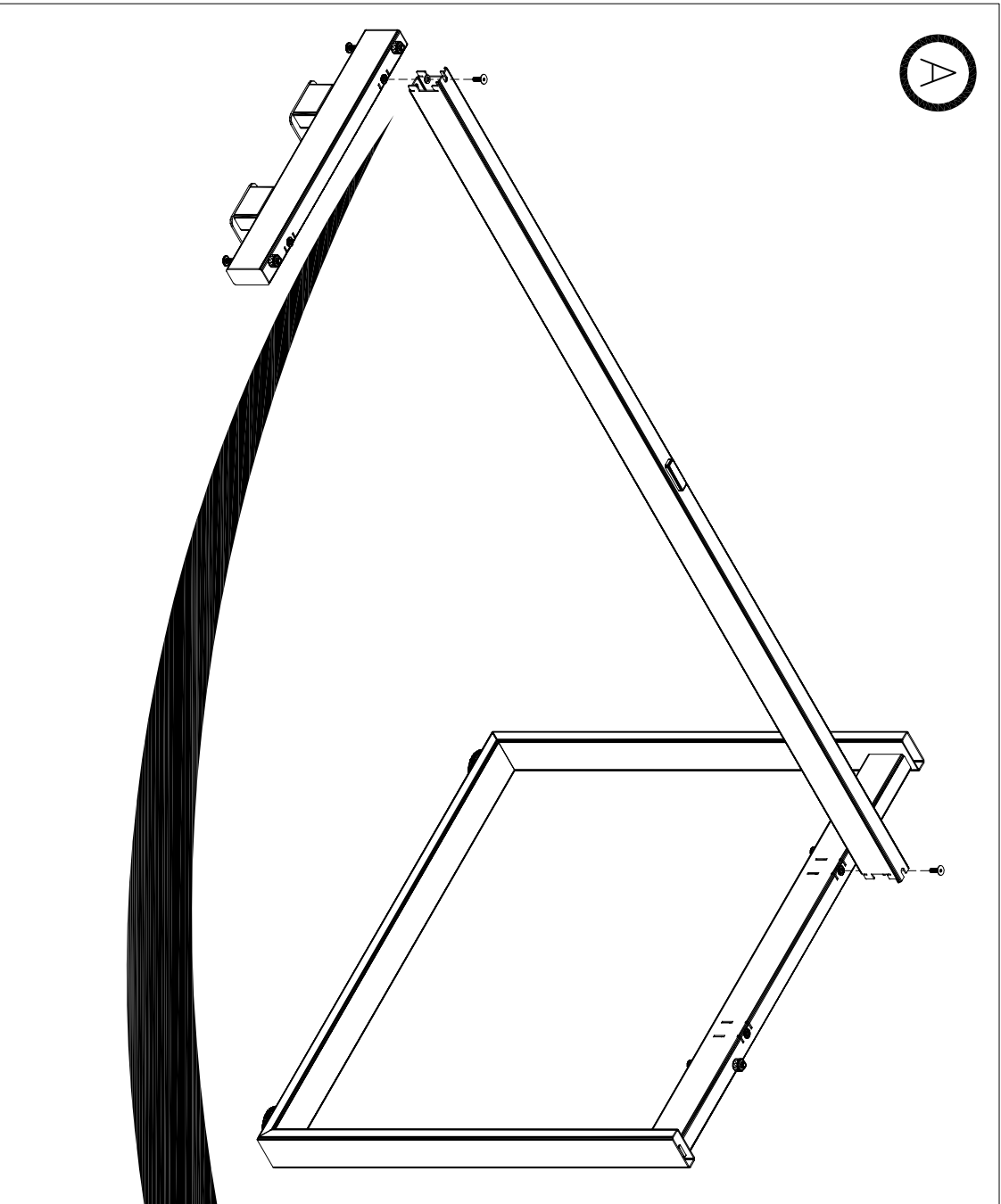

(A)

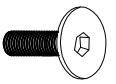
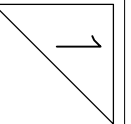

M6x20B

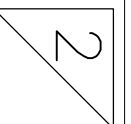

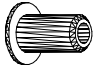
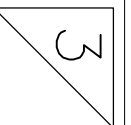

M6

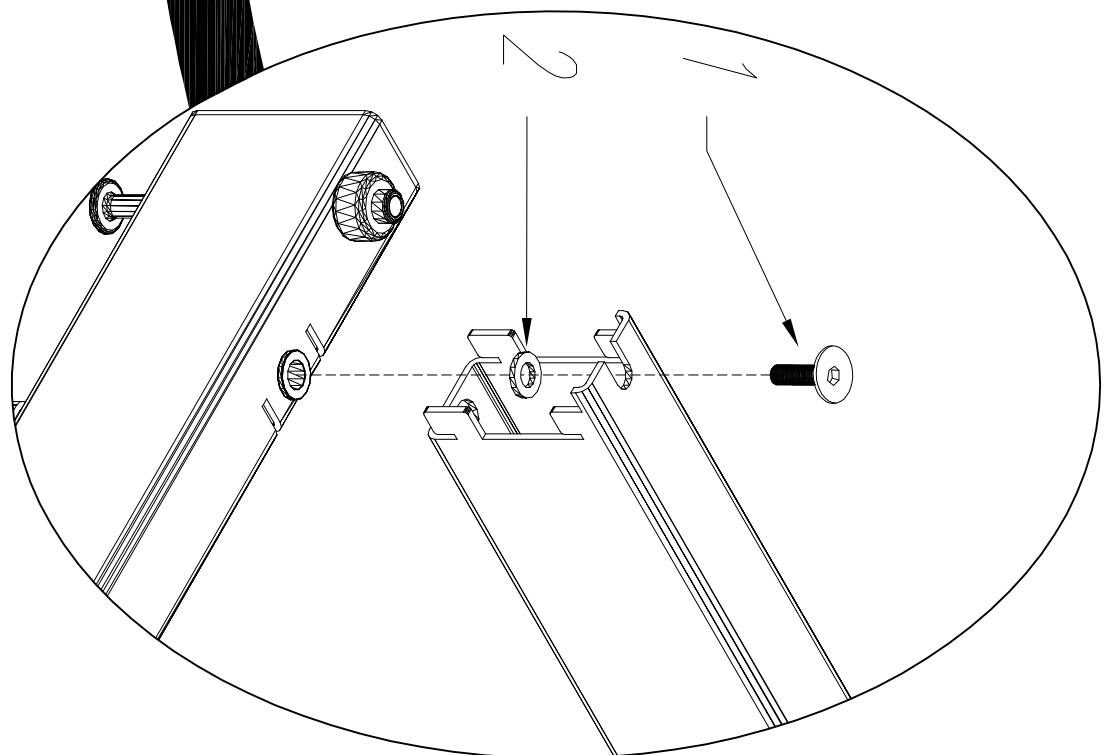

M6



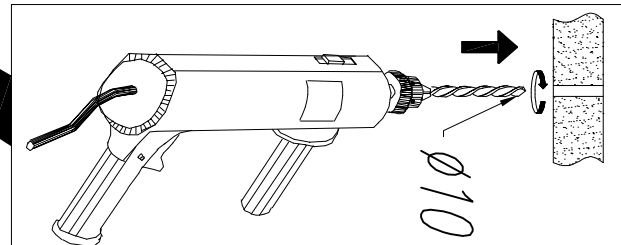
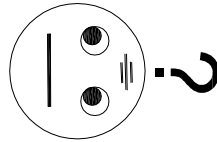
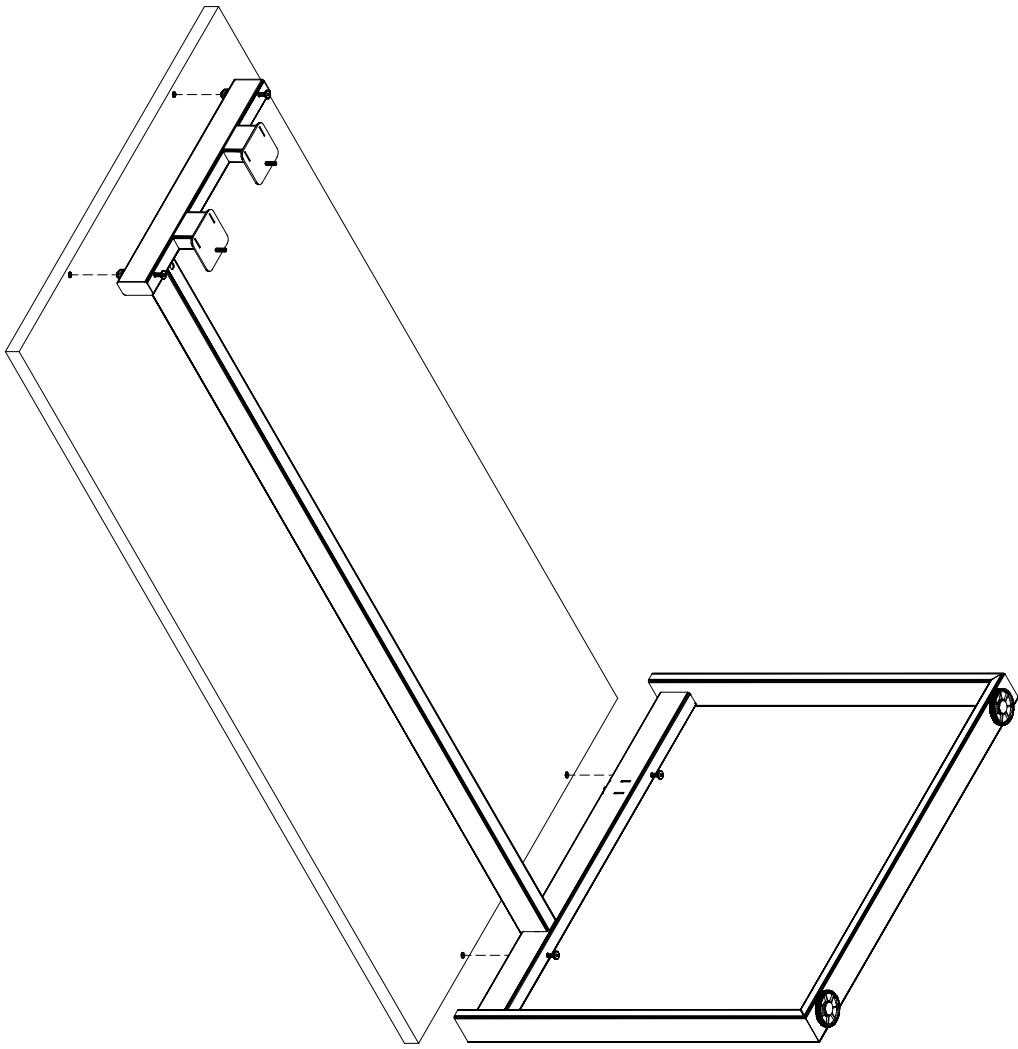

OGI

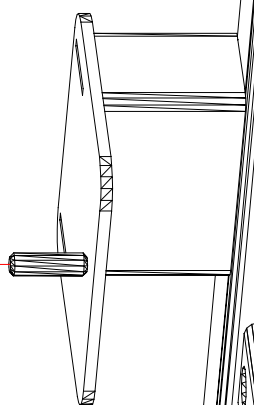
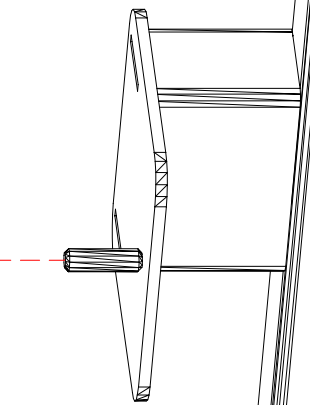
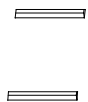

D



3

