

(A)

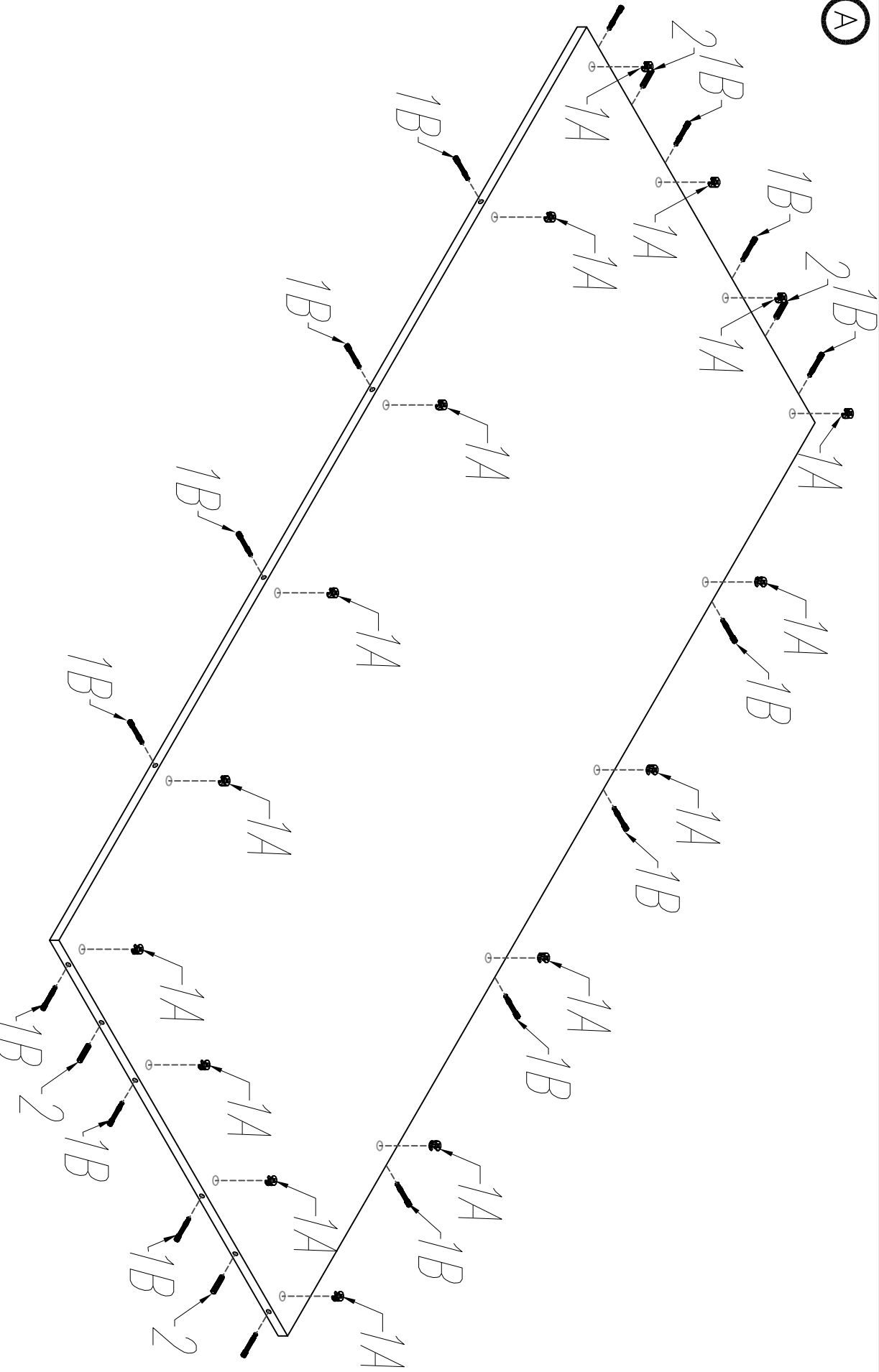

MIT19
MIT21

KOLEJNOŚĆ MONTAŻU
MIMOSPODÓW I KOLKÓW.
THE FITTINGS SEQUENCE OF THE
CAMS AND DOWELS.
DIE MONTAGEFOLGE VON
EXZENTERN UND DÖBELN.

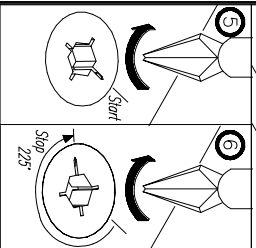
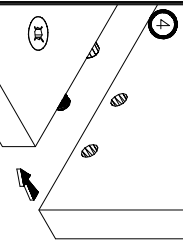
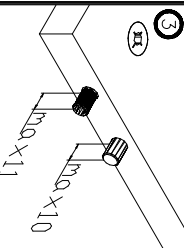
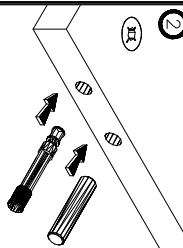
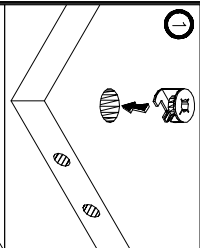

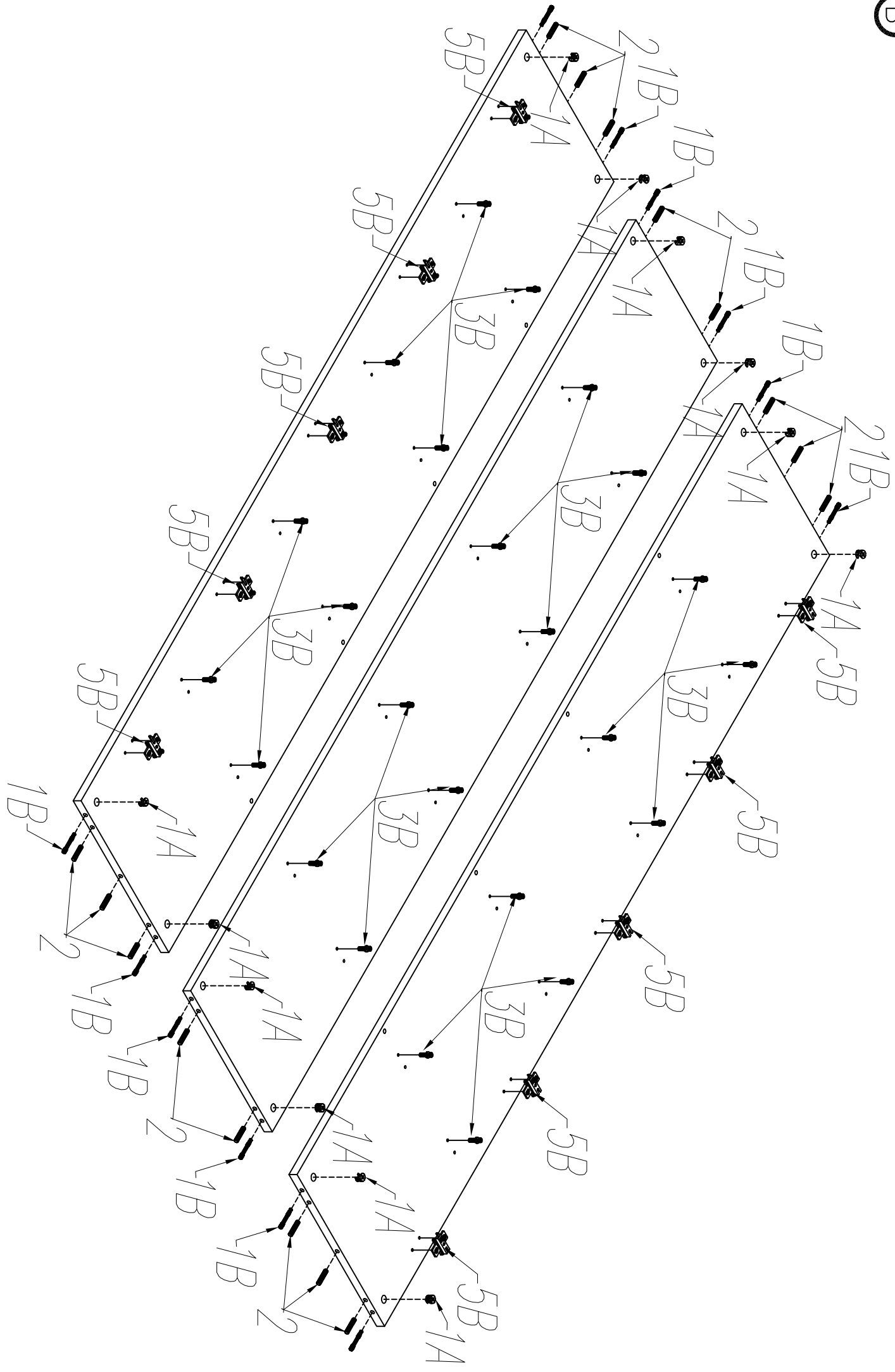

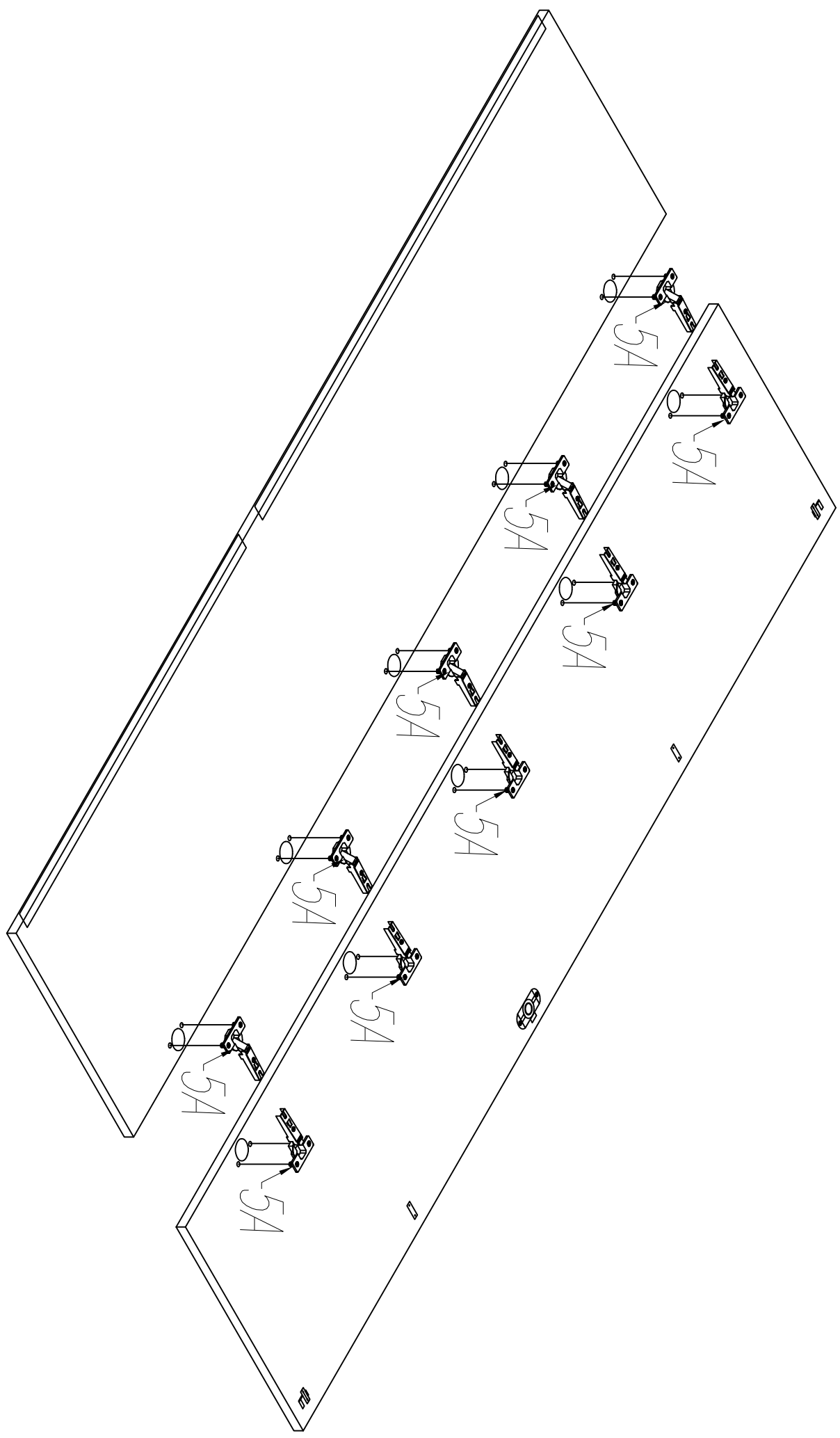

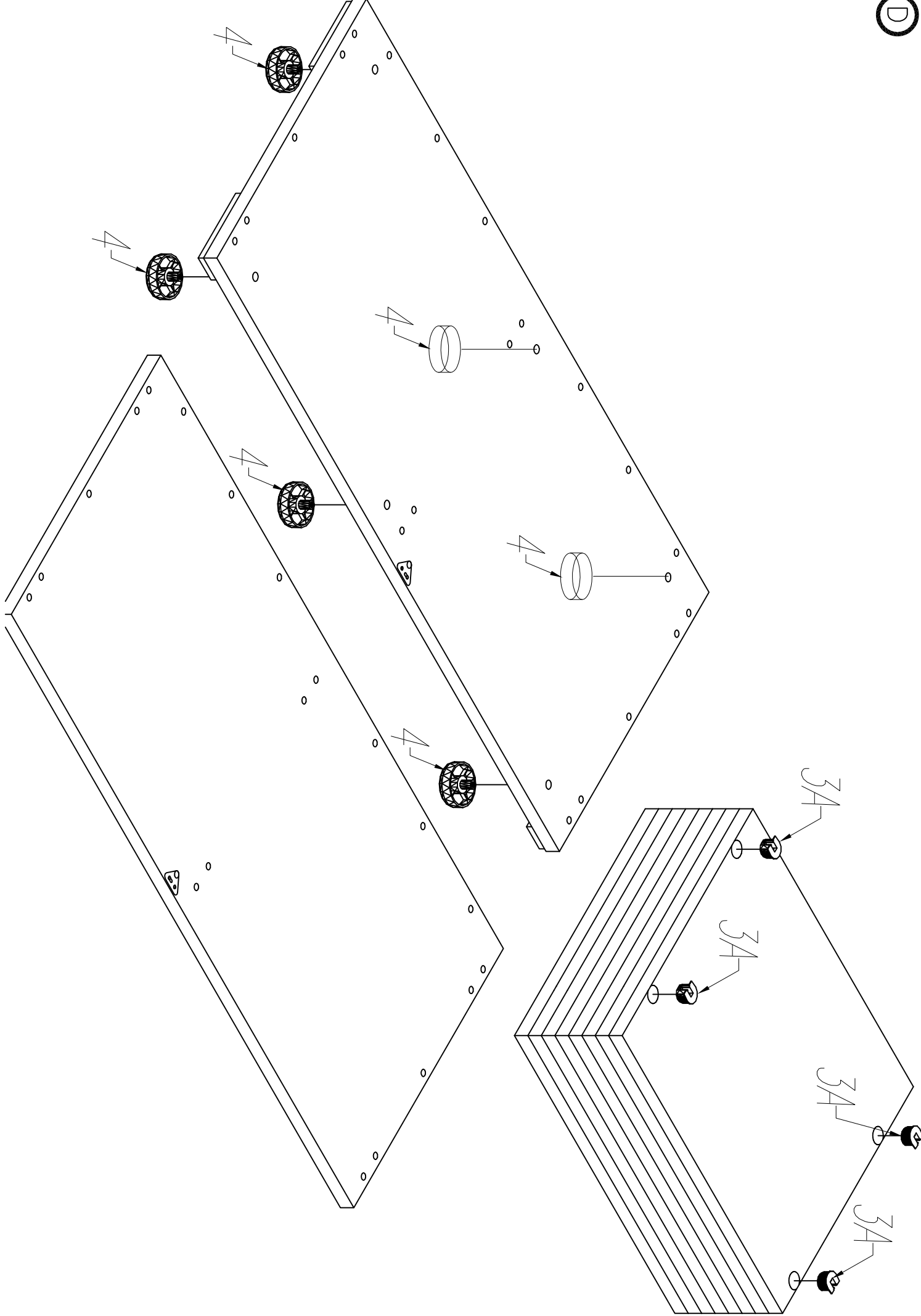

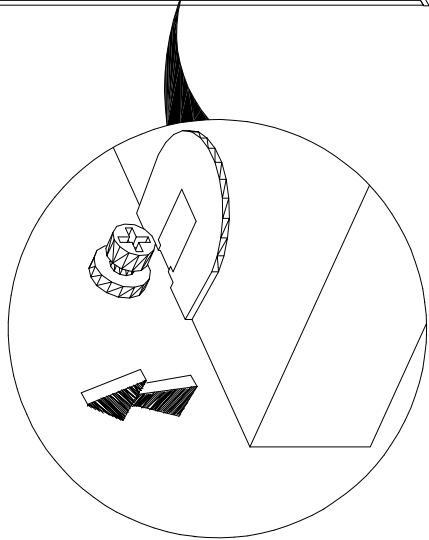
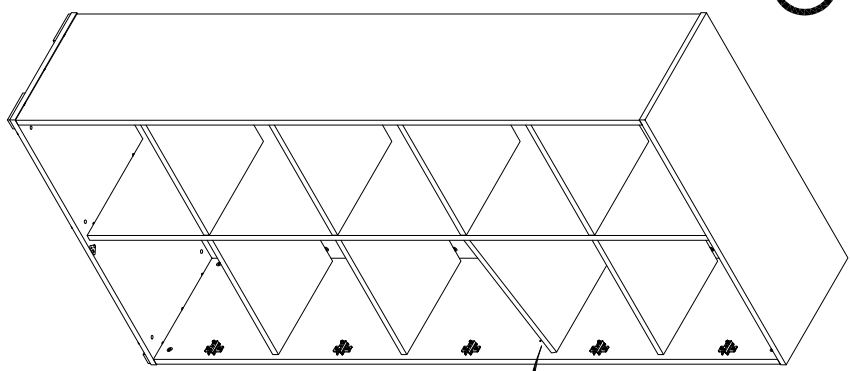
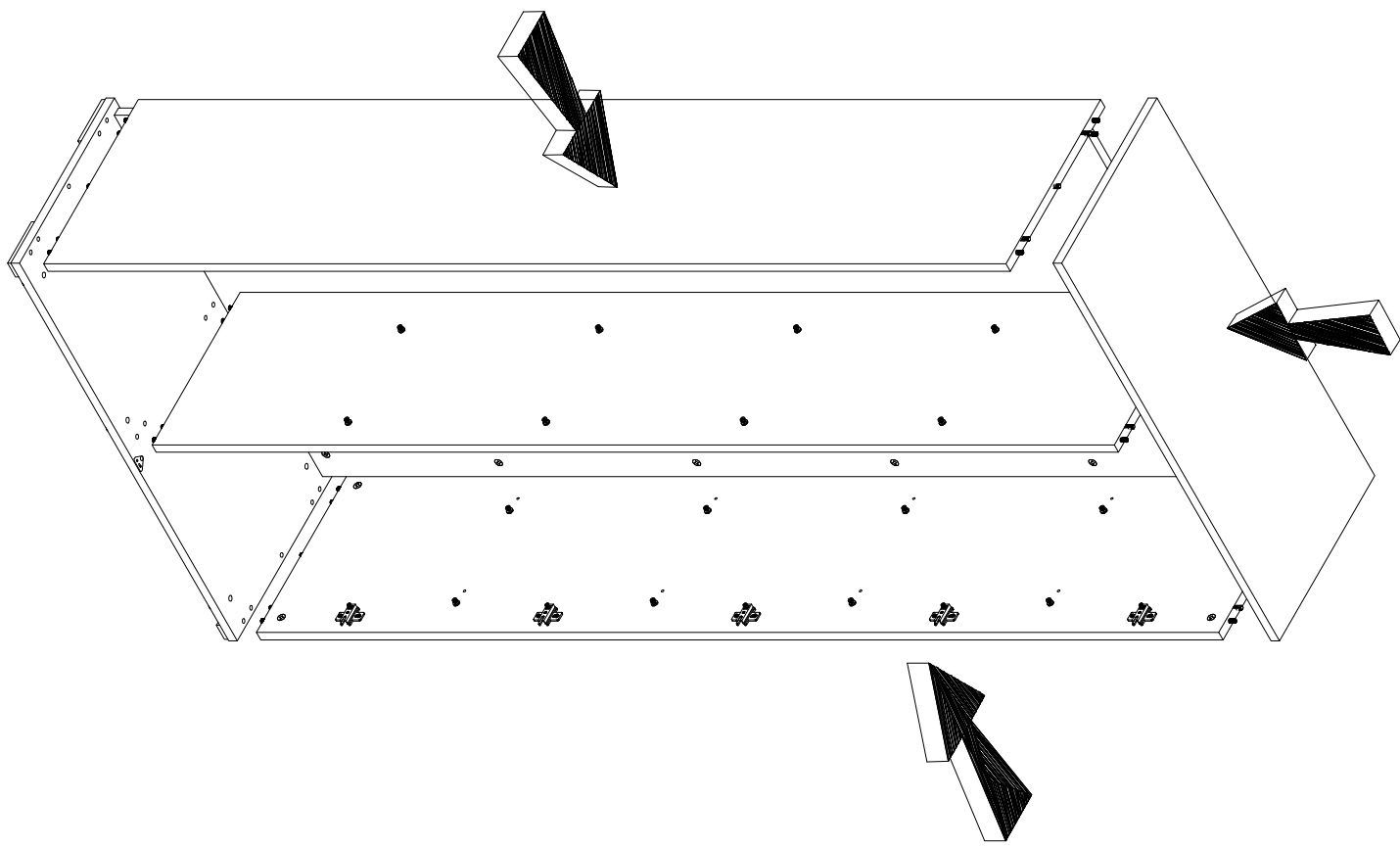

MIT19

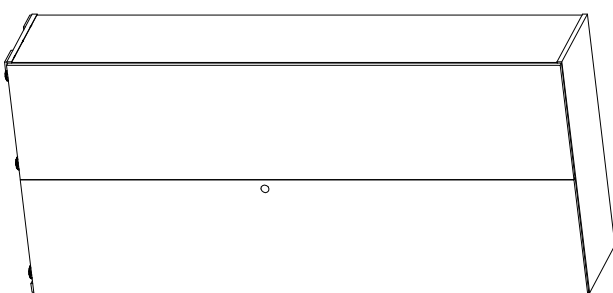

MIT21

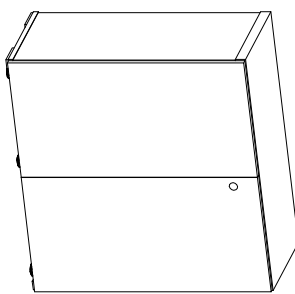

- 1 1x1
 2 1x1
 3 2x2
 4 2x2
 5 1x1
 6 2x2

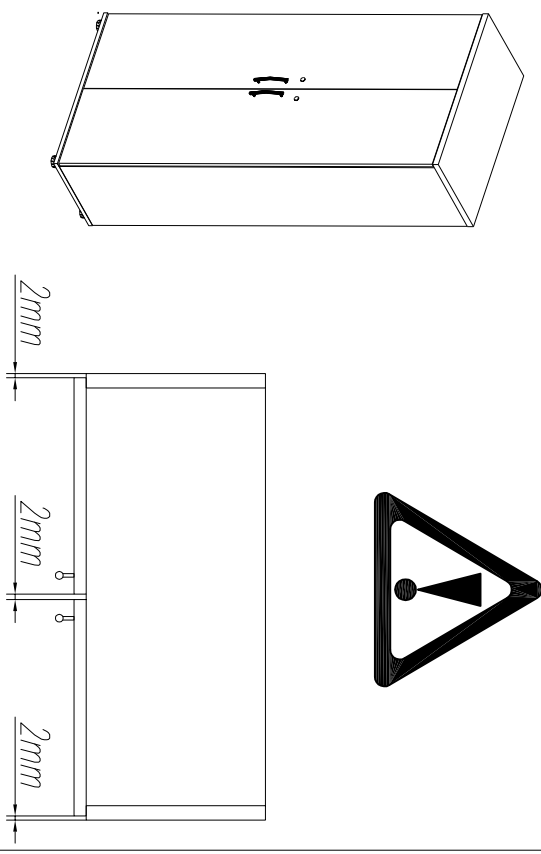
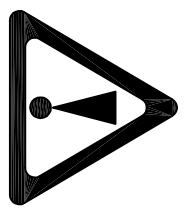
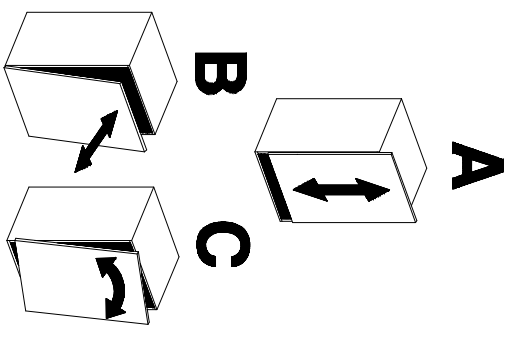
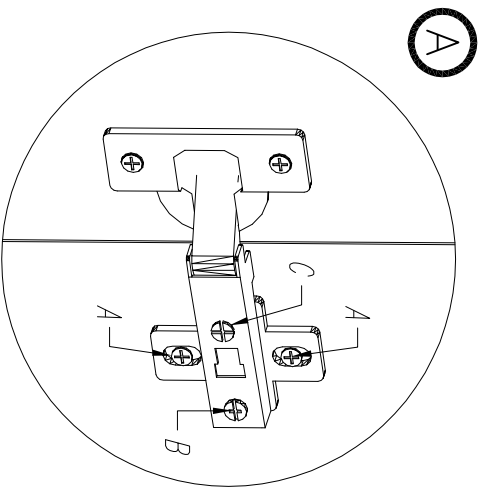

(B)

