

(A)

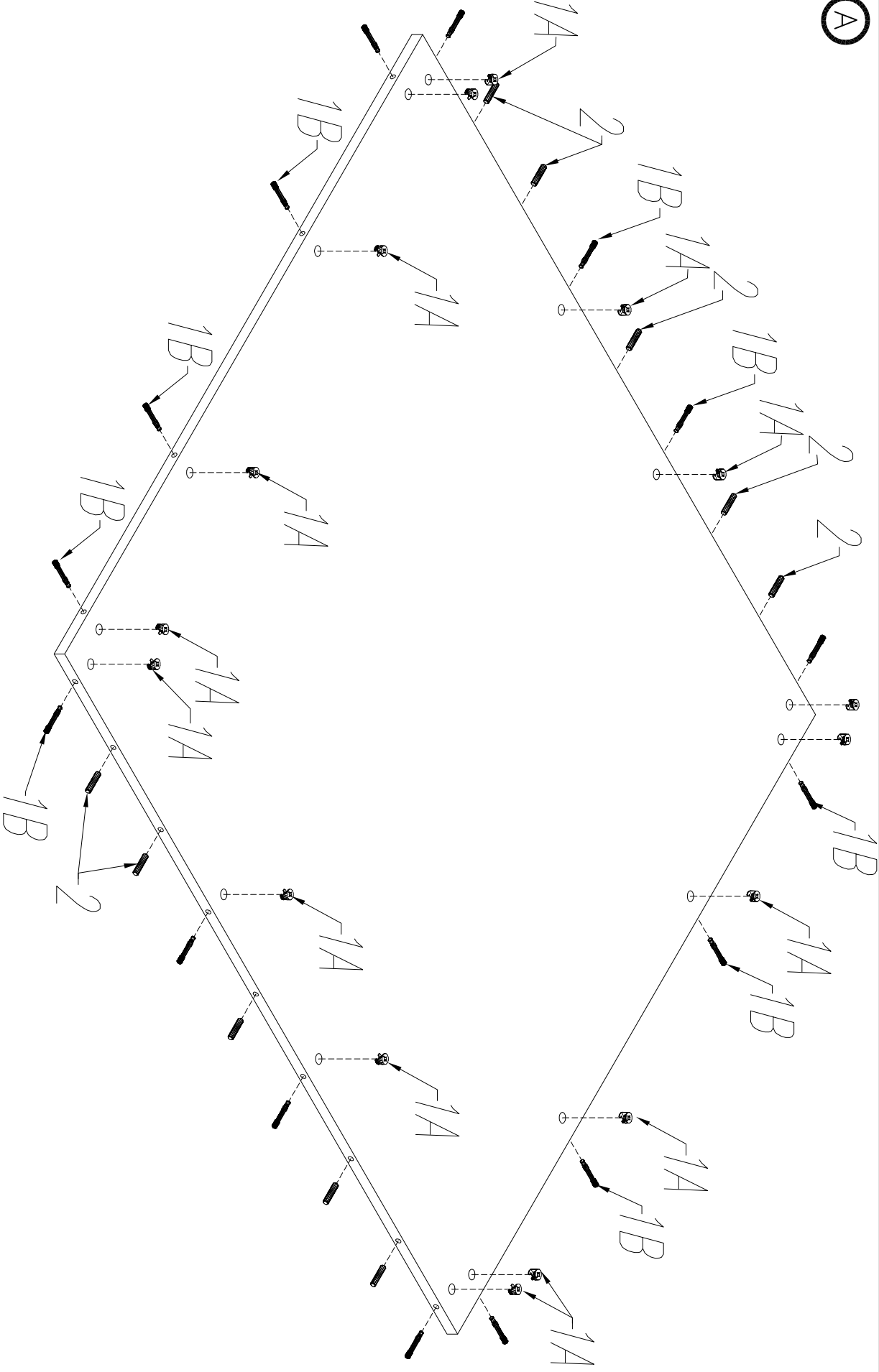

MIT20

KOLEJNOŚĆ MONTAŻU
MIMOSRODÓW I KOLKÓW.
THE FITTING SEQUENCE OF THE
CAMB AND DOMELS.
DIE MONTAGEFOLGE VON
EXZERNERN UND DREHEN.

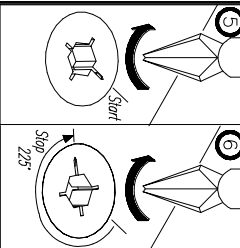
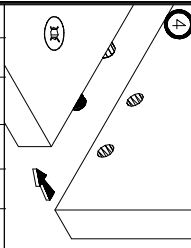
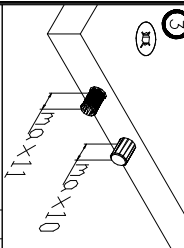
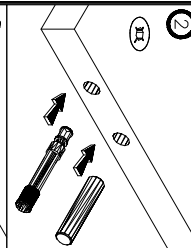
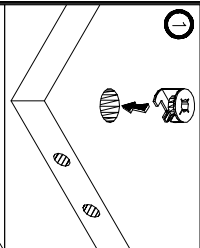

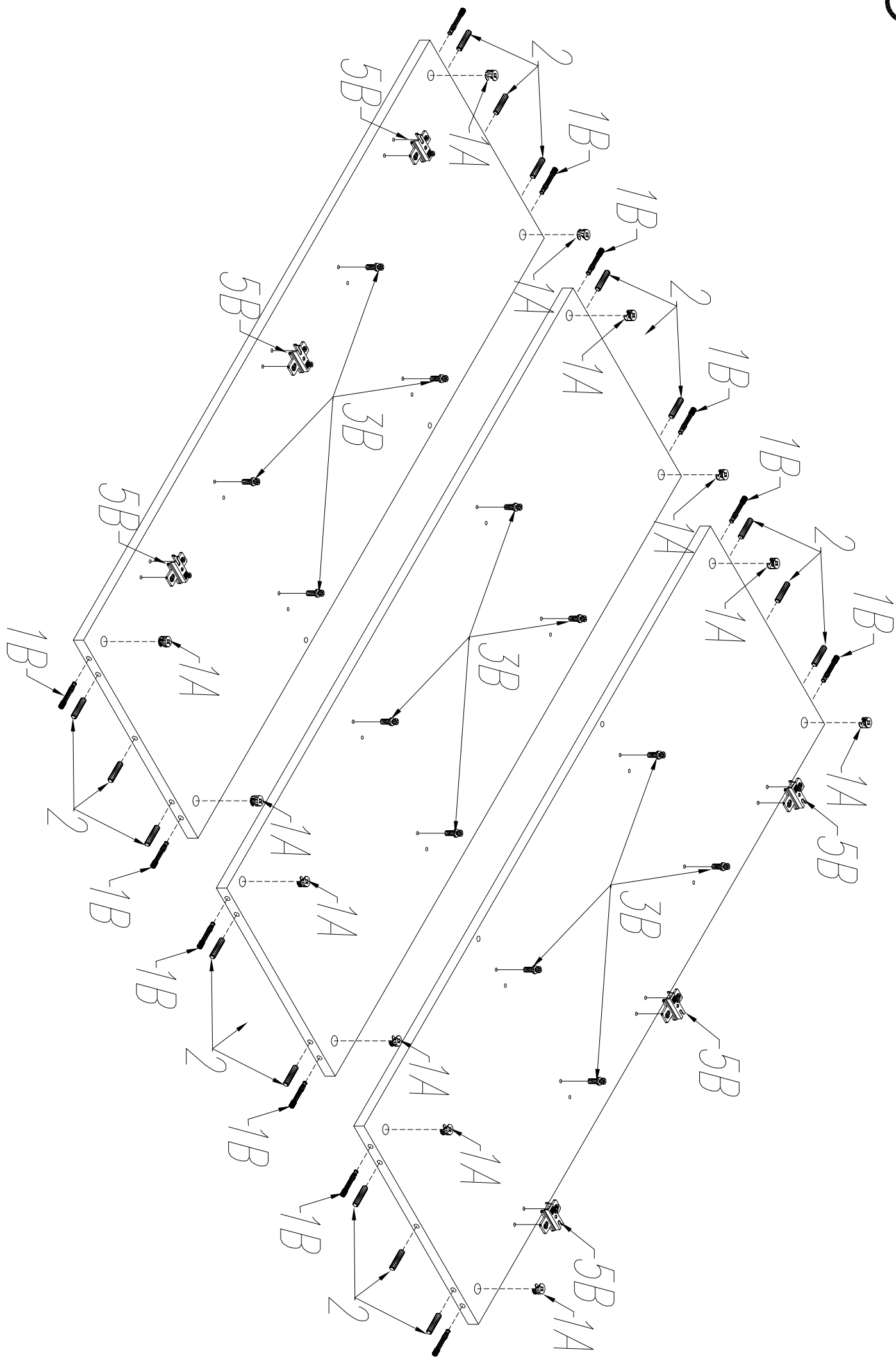

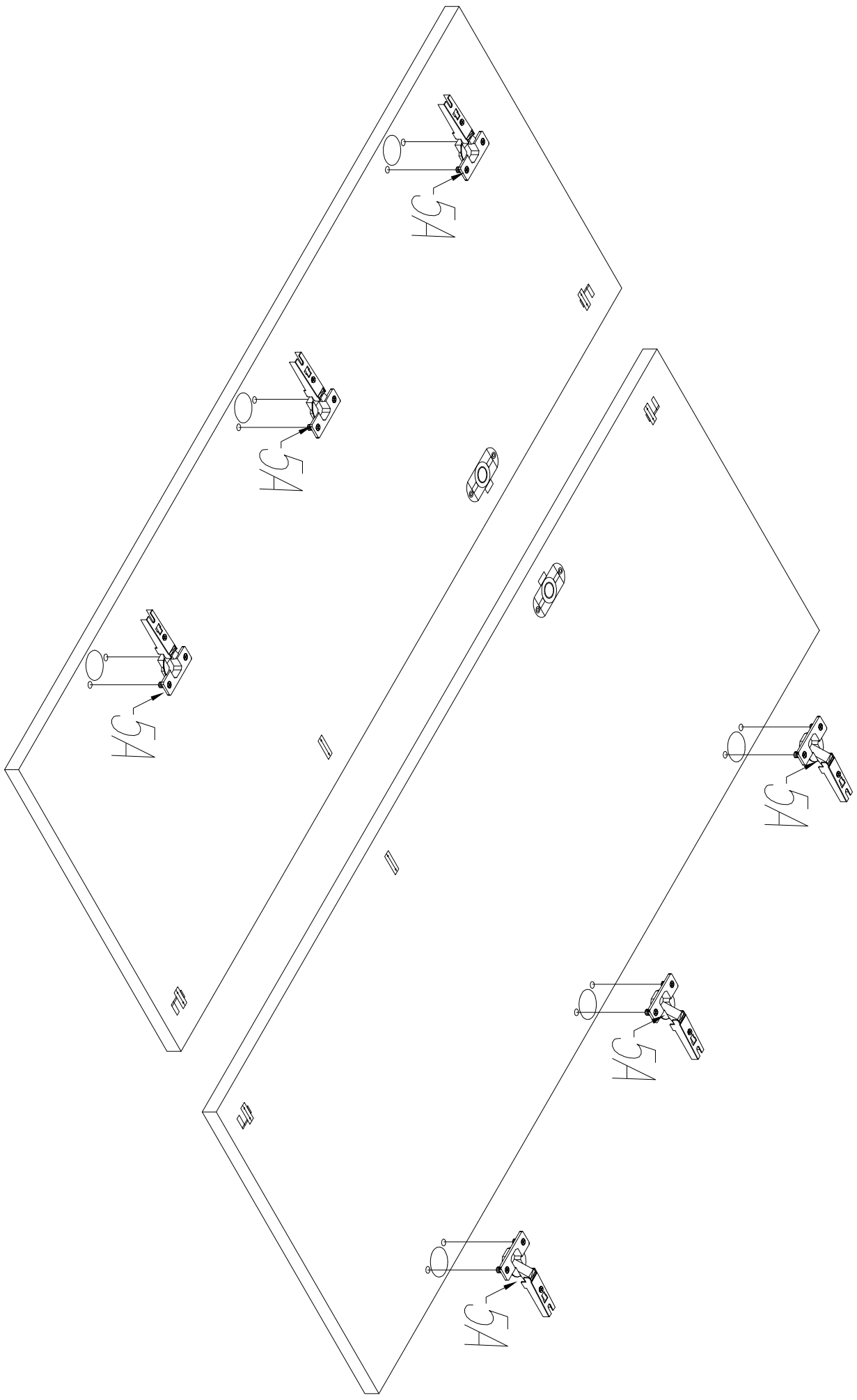

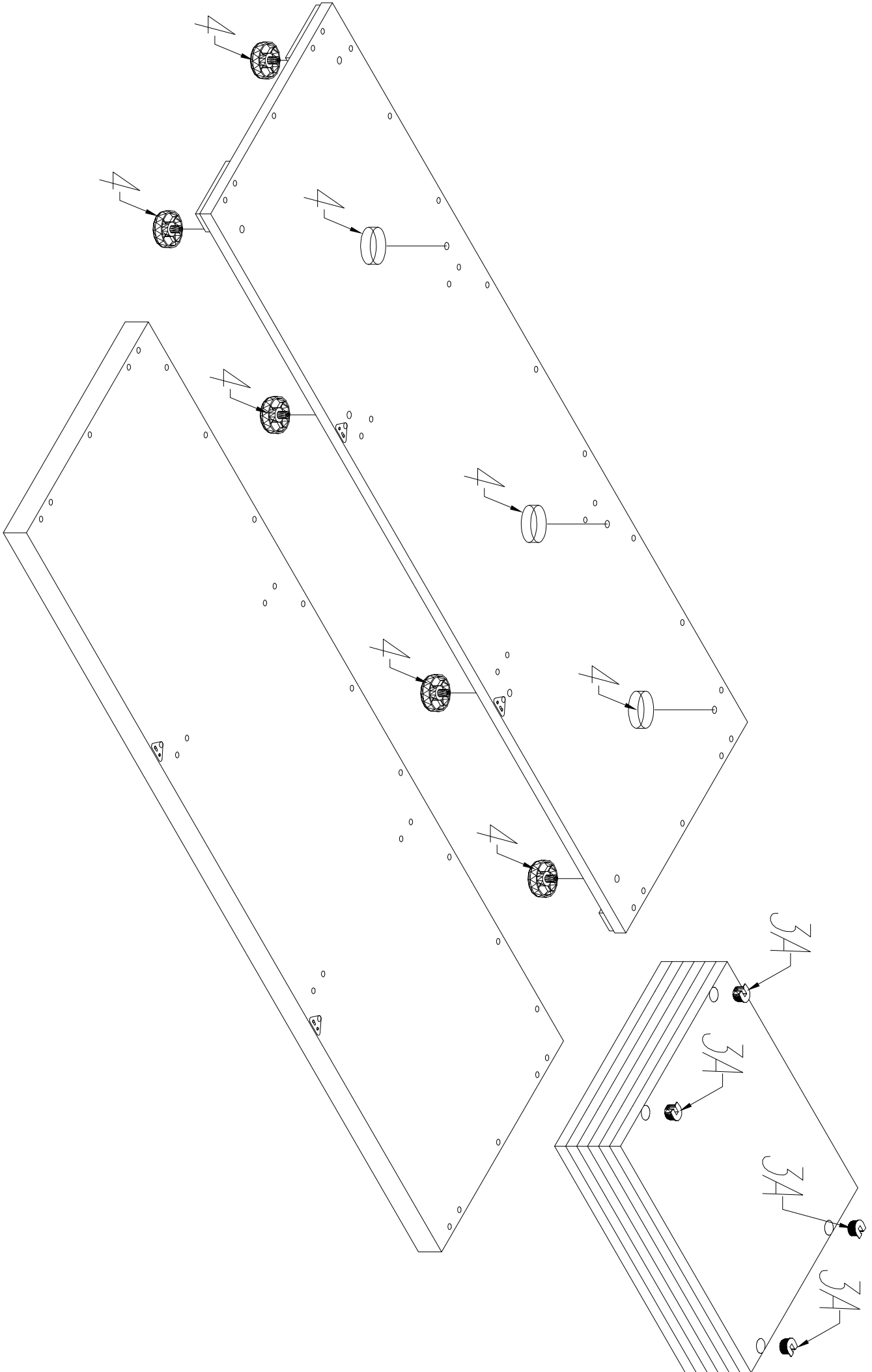

F

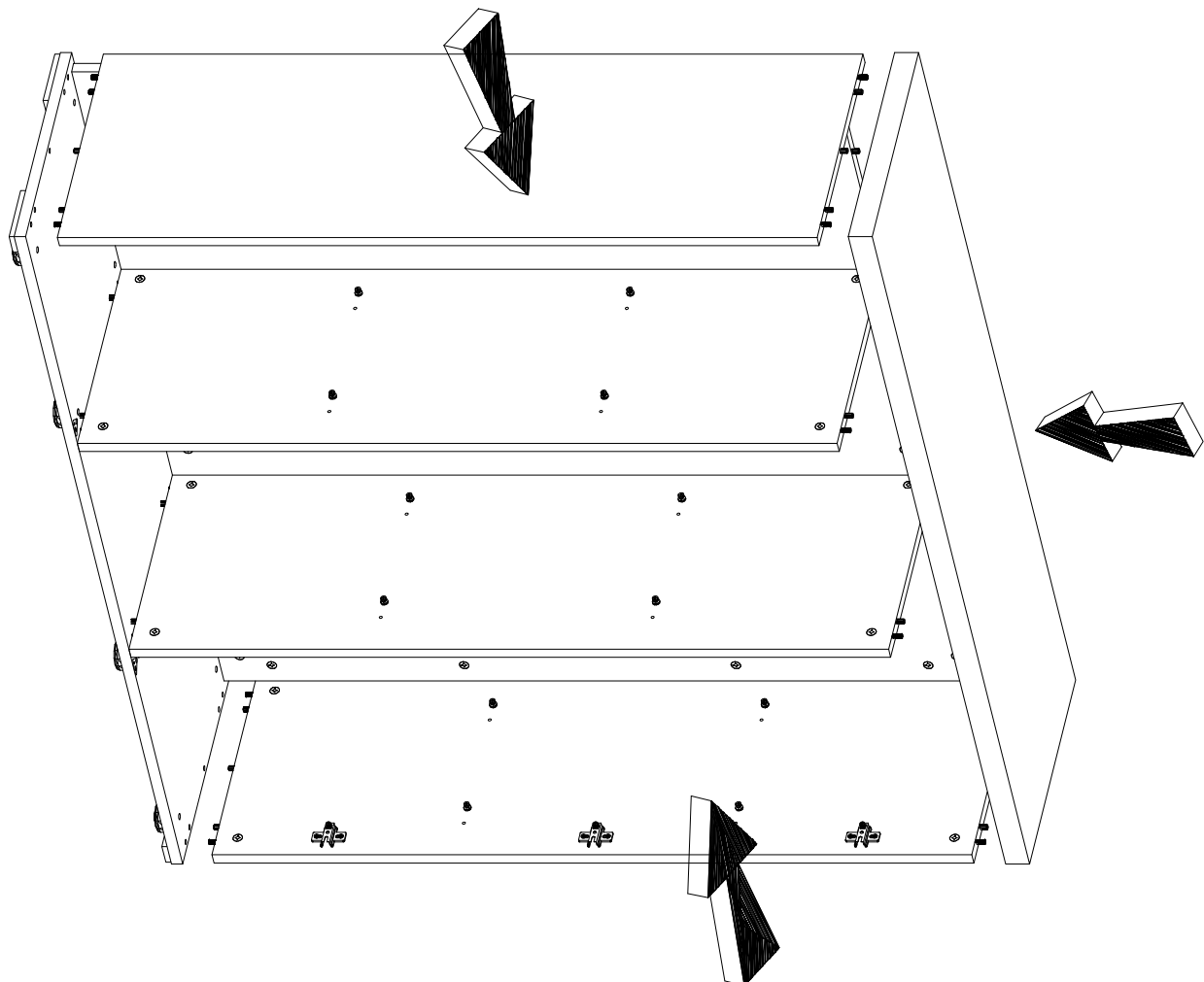

F

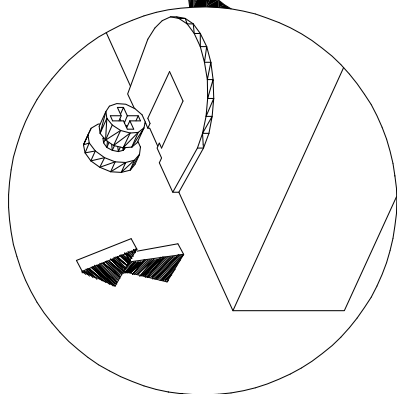
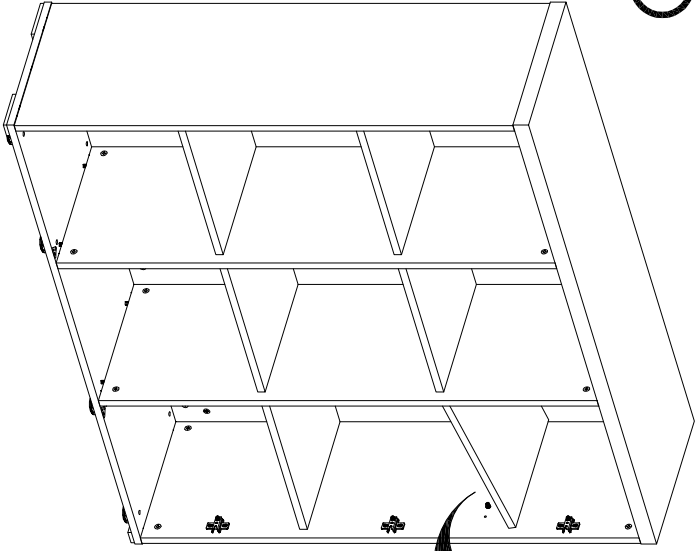

G

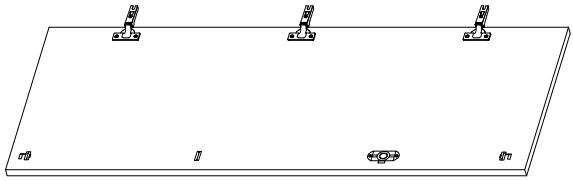
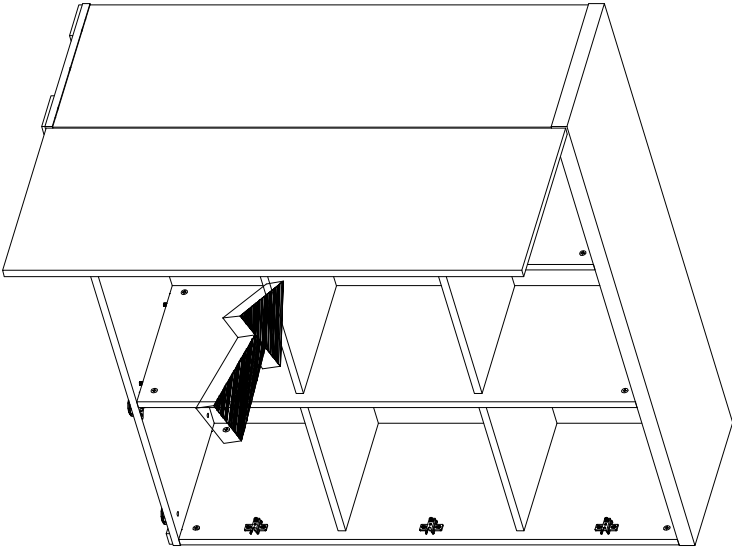

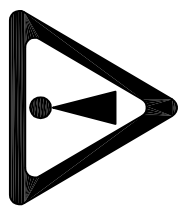
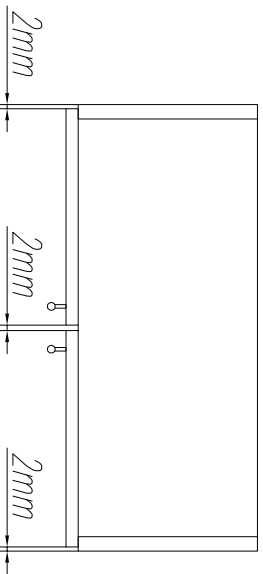
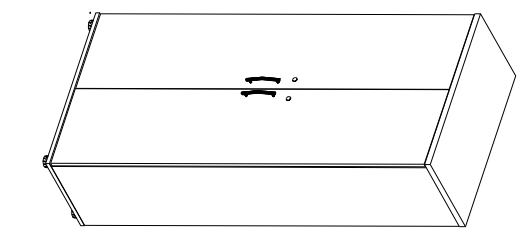
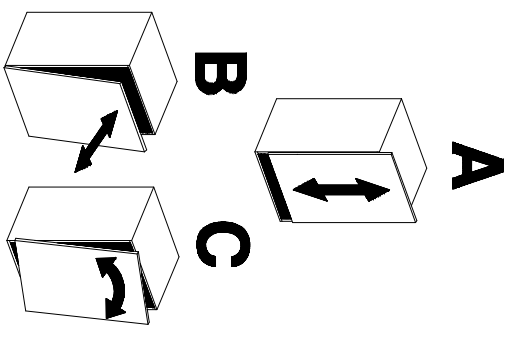
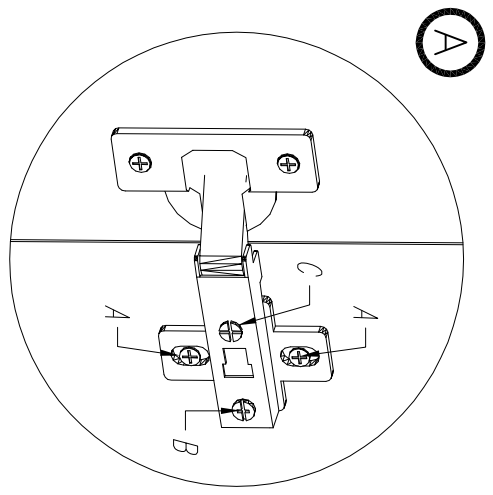
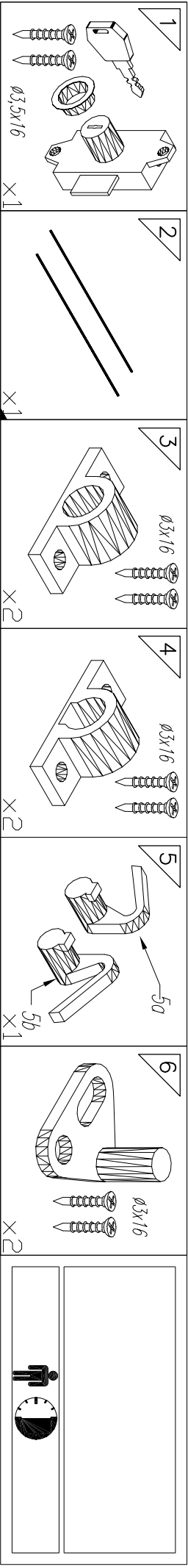

B

