

ku

bi

ck

 **bralco**
the next office

kubick

Shape your space

Kubick è un sistema integrato di paretine con telaio perimetrale ad elevata modularità, su piedini o con zoccolo cablabile. Disponibile in una vasta gamma di finiture e accessori.

Kubick is an integrated screen system with high modularity made of framed panels on feet or plinth for cable management. A wide range of finishes and accessories are available.

Kubick est un système intégré de cloisons avec un cadre périmétrique à haute modularité, sur pieds ou avec un socle qui peut être câblé. Disponible dans une large gamme de finitions et d'accessoires.

Kubick ist ein integriertes Stellwandssystem mit hochmodularem Umfangsrahmen, auf Füßen oder Sockel mit Kabeldurchführung. Lieferbar in einer großen Auswahl an Oberflächen und Zubehör.

Kubick es un sistema integrado de paneles con un marco perimetral de alta modularidad, con pies o con zócalos para los cables. Está disponible en una amplia gama de acabados y accesorios.

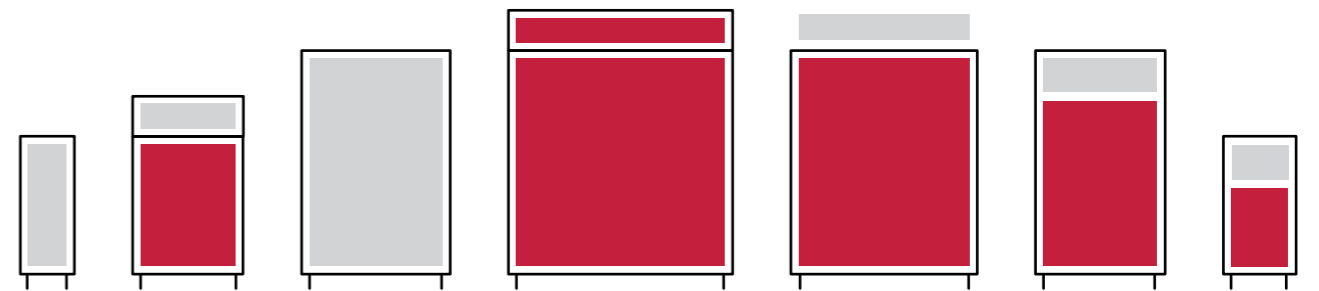





**Dai vita ad accoglienti spazi
multifunzionali utilizzando l'ampia
gamma di elementi ed accessori
a disposizione.**

Maximize function and appeal using the wide range of elements and accessories.

Donnez vie à des espaces multifonctionnels confortables en utilisant la large gamme d'éléments et d'accessoires disponibles.

Dank der großen Auswahl an Elementen und Zubehör können Sie gemütliche Mehrzweckräume schaffen.

Das vida a acogedores espacios multifuncionales utilizando la amplia gama de elementos y accesorios disponibles.

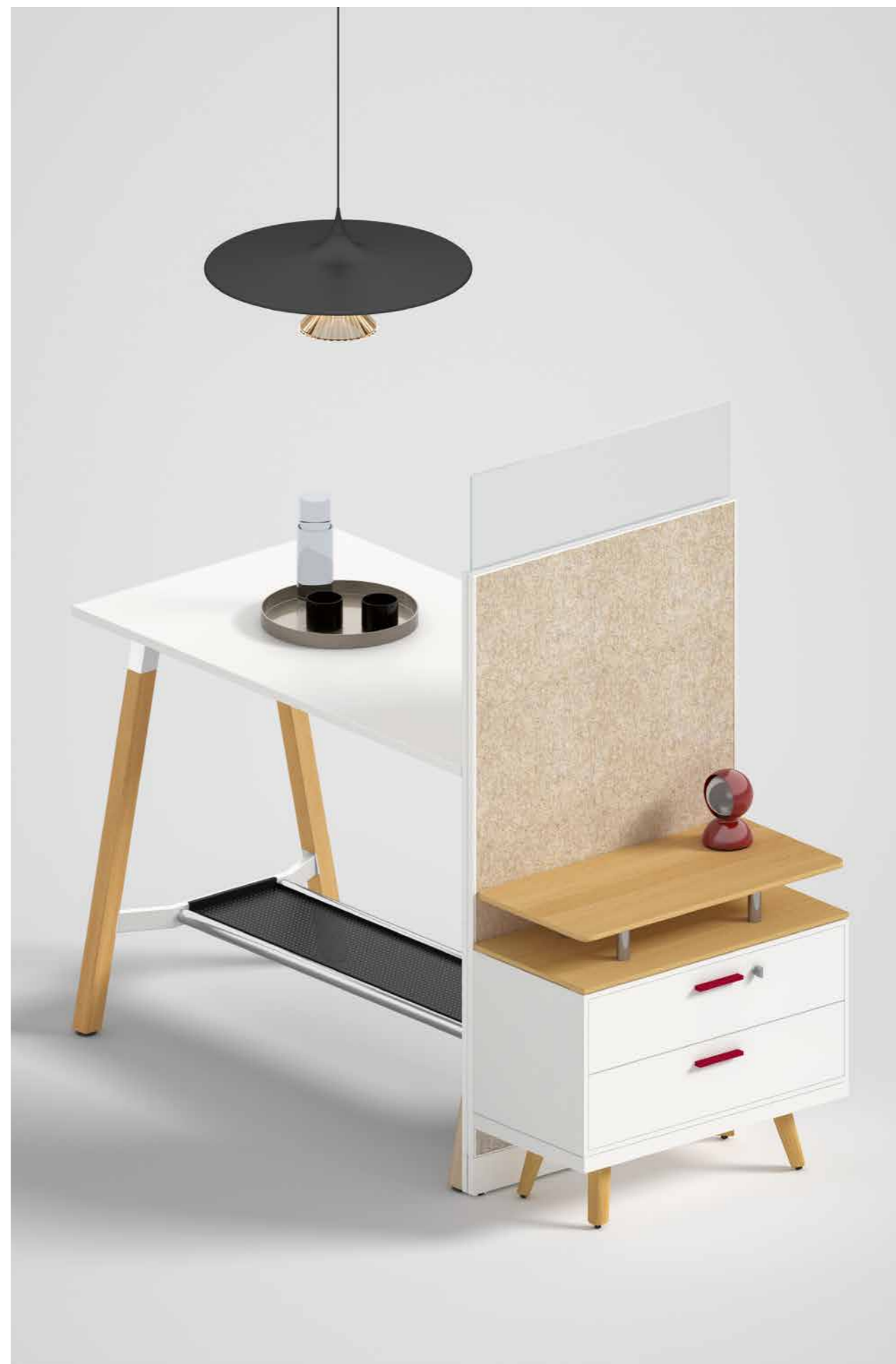



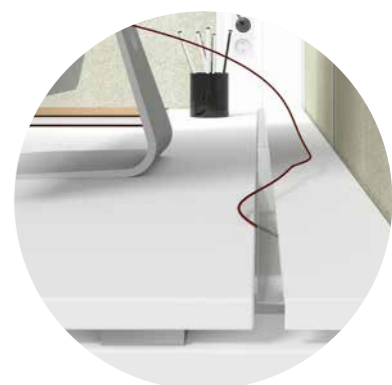
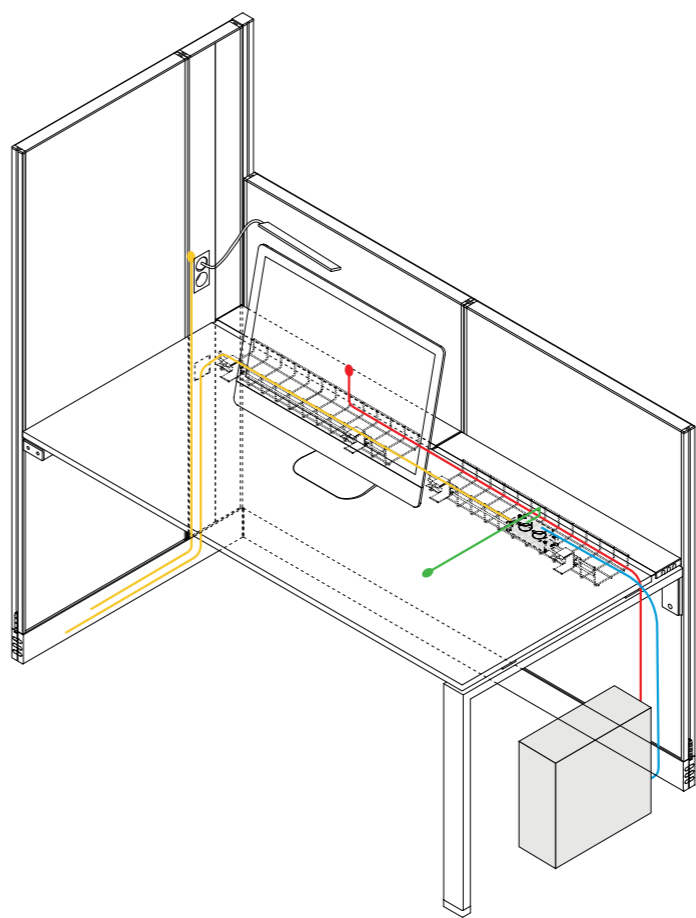





Ogni modulo è accessoriabile in maniera indipendente per creare uno spazio di lavoro personalizzato.

Modularity and accessories adapt to personal preference and demands of multiple job functions.
Chaque module peut être équipé indépendamment avec plusieurs accessoires pour créer un espace de travail personnalisé.
Jedes Modul kann unabhängig ausgestattet werden, um einen personalisierten Arbeitsbereich zu erstellen.
Cada módulo puede ser anexionado independientemente para crear un espacio de trabajo personalizado.





Design e finiture contemporanee per un sistema di screen integrato, moderno e prestazionale.

Contemporary design and finishes for an integrated, modern and high-performing screen system.

Design et finitions contemporains pour un système d'écrans intégré, moderne et performant.

Zeitgemäßes Design und Oberflächen für ein integriertes, modernes und leistungsstarkes Stellwandsystem.

Diseño y acabados contemporáneos para un sistema de pantalla integrado, moderno y de alto rendimiento.







**Cellule protette acusticamente
per soluzioni flash meeting,
break area o attesa.**

Dedicated sound proof working cells,
for flash meetings, break out areas or
welcome lounges.

Cellules acoustiques pour des
réunions flash, des zones de pause ou
des solutions d'attente.

Akustisch geschützte Bereiche
gestatten Lösungen wie Wartezone,
Pausenraum oder Flash-Meeting Platz.

Habitaculos acústicamente protegidos
para reuniones rápidas, áreas de
descanso o de espera.





moduli • modules • modules •
Module • módulos

d: 4 cm

w: 40÷160 cm

w: 60÷120 cm

h: 24 cm

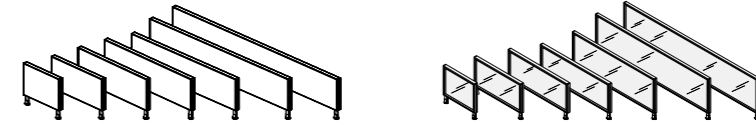

h: 24 cm

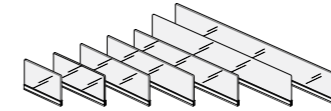

h: 113,5 cm
h: 161,5 cm

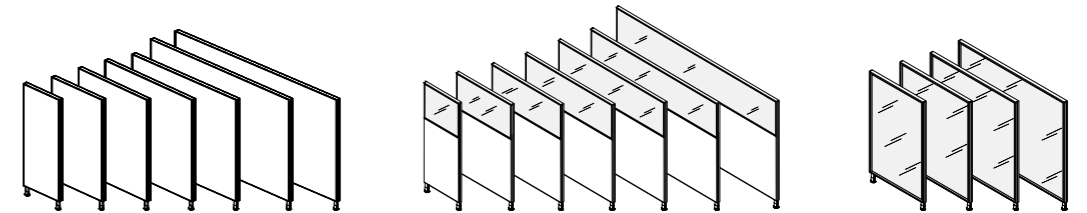

d: 4 cm

w: 4 cm

h: 23,5 cm
h: 103,2 cm
h: 113,5 cm
h: 151,2 cm
h: 161,5 cm

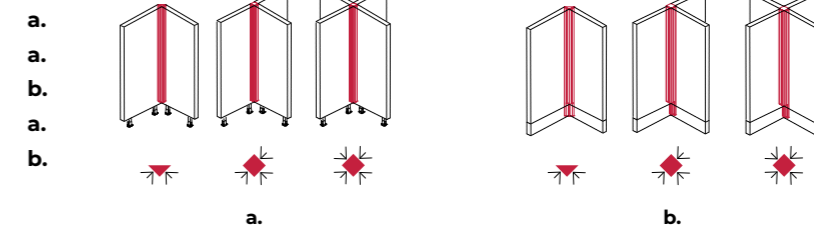

d: 4 cm

w: 20 cm

h: 113,5 cm

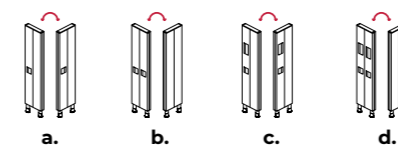

h: 161,5 cm

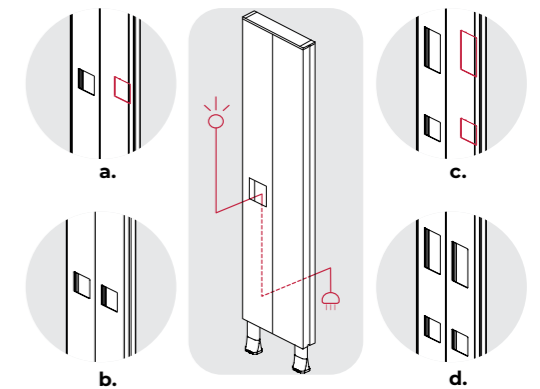
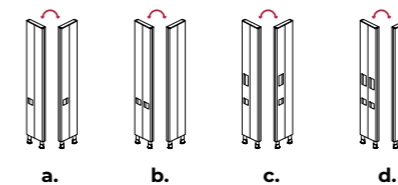

componenti • components • composants • Einzelteile • componentes

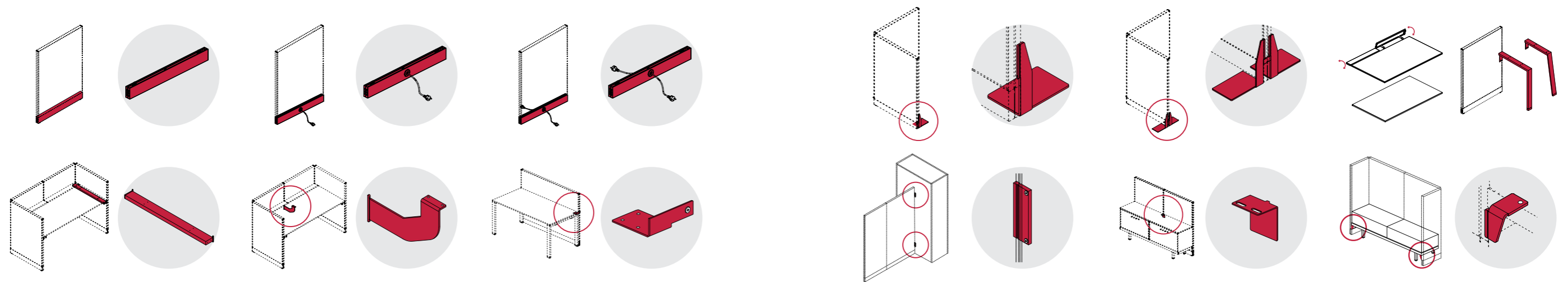

accessori per pannello • accessories for panel • accessoires pour panneau • Paneel-Zubehör • accesorios para panel

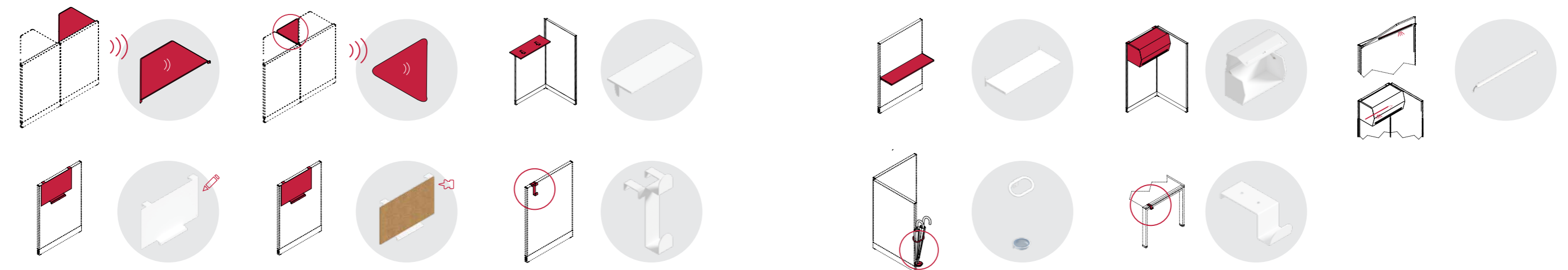

accessori per barra porta-accessori • accessories for accessory-holder bar • accessoires pour barre porte-accessoires • Zubehör für Zubehör-Halterleiste • accesorios para barra porta accesorios

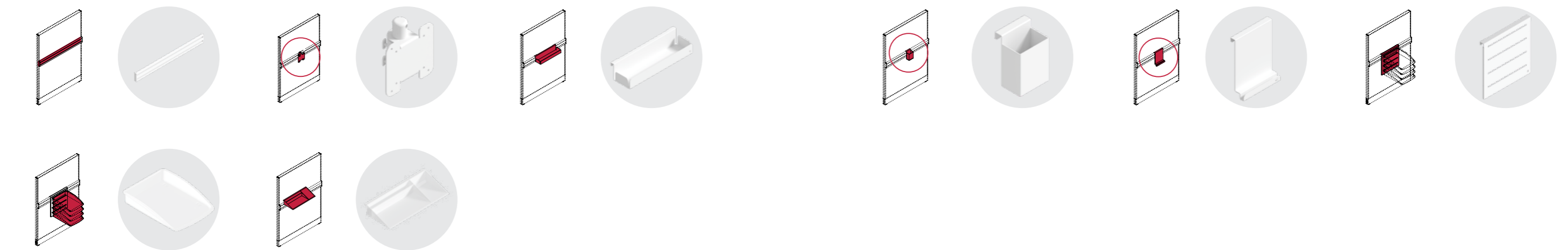

tessuto • fabric • tissu • Stoff • tejido

MIRAGE

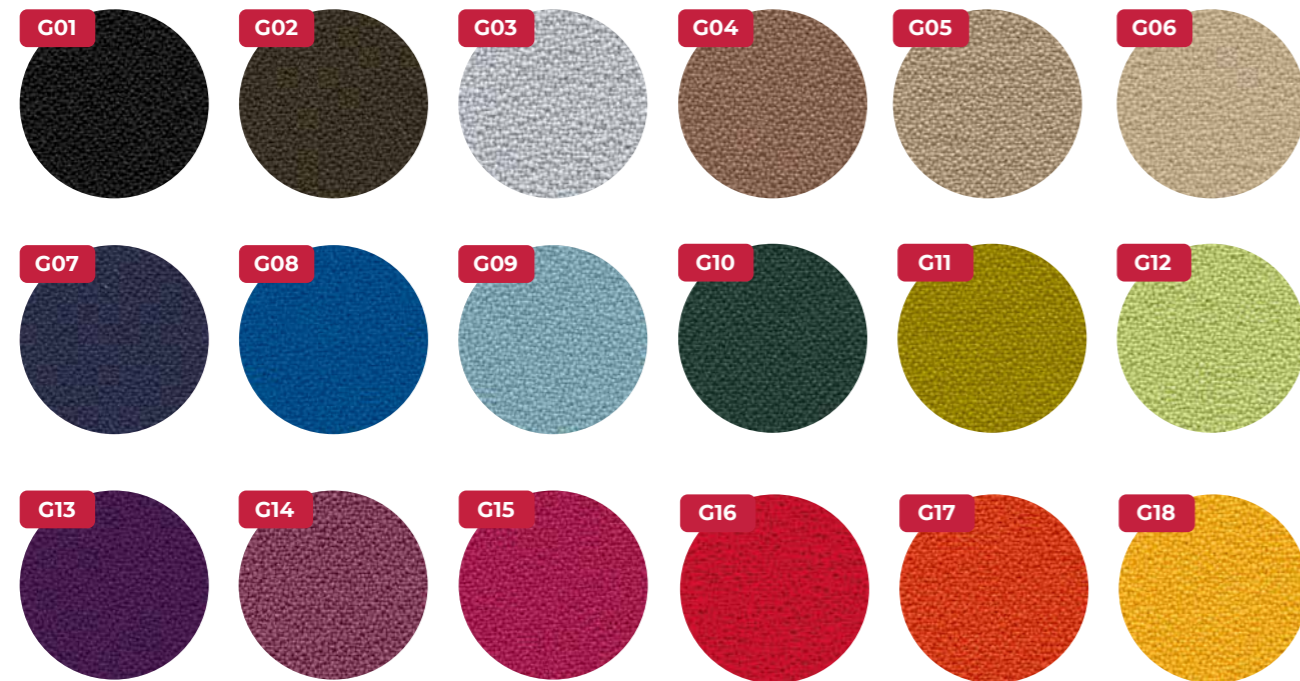

NEMI MELANGE

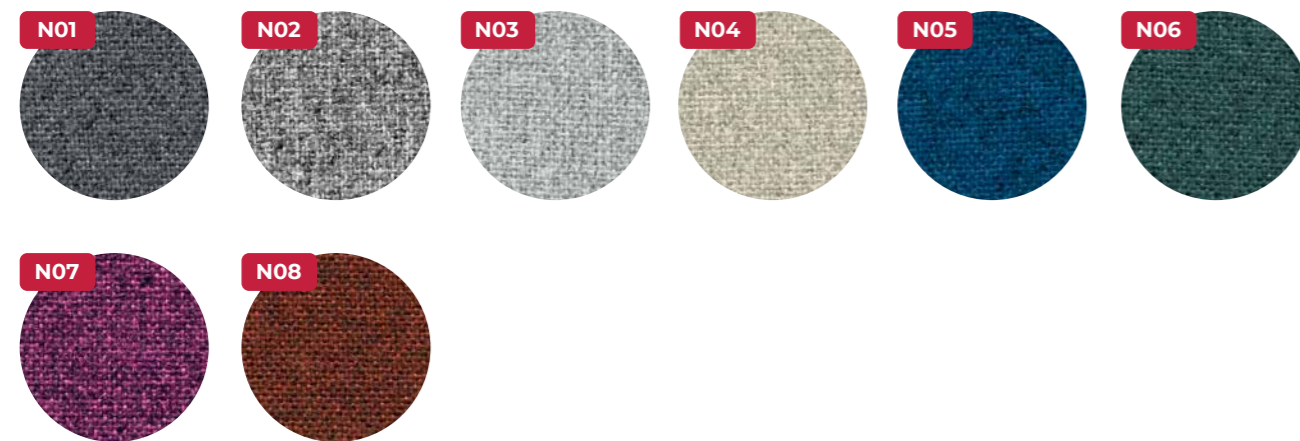

FENICE

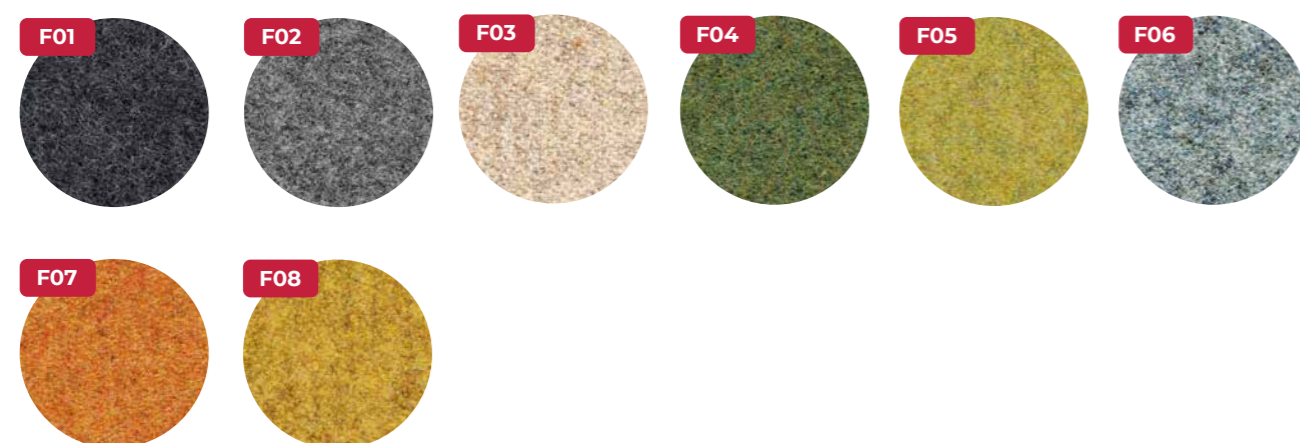

metallo • metal • métal • Metall • metal

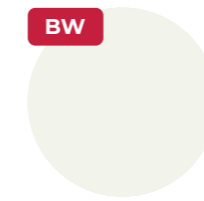

bianco
white
blanc
weiß
blanco

melaminico • melamine • mélamine • Melamin • melamina

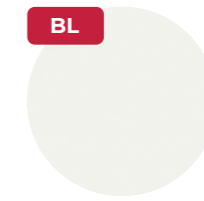

bianco
white
blanc
weiß
blanco

vetro temperato • tempered glass • verre trempé • gehärtetes Glas • vidrio templado



trasparente
transparent
transparent
transparentes
transparente

Edizione Novembre 2020 - Particolari tecnici ed estetici possono essere modificati senza preavviso. Le rese cromatiche non sono vincolanti così come la fedeltà della riproduzione. Dati, misure e dettagli devono essere verificati con il listino.

November 2020 edition - Technical and aesthetic details can be modified without notice. Colour rendering may differ. Check the data, measures and details on the price list.

Édition novembre 2020 - Les détails techniques et esthétiques peuvent être modifiés sans préavis. Le rendu chromatique n'est pas contractuel, ainsi que la fidélité de la reproduction. Les données, les mesures et les détails doivent être vérifiés avec le tarif.

Ausgabe November 2020 - Technische und ästhetische Details könnten ohne Vorankündigung geändert werden. Die Echtheit der Farbwiedergabe ist nicht verbindlich. Daten, Maße und Details sind in der Preisliste zu überprüfen.

Edición de noviembre de 2020 - Los detalles técnicos y estéticos pueden ser modificados sin preaviso. Los rendimientos de color y la fidelidad de la reproducción no son vinculantes. Los datos, las medidas y los detalles deben ser verificados con la tarifa.

 **bralco**

Kubick

design R&D Bralco
project: gherardi architetti
images: gherardi architetti
printed: Imoco Spa

thanks to: Artemide, Davide Groppi, Flos, Linea Light

Bralco Srl - Via Luigi Einaudi, 1 - 31058 Susegana TV - Italy
T +39 0438 43 77
info@bralco.it - www.bralco.it

